

AU 3~8KESL USER MANUAL

Scan Here for Austa Solar App



ios



Android

SINGLE PHASE HYBRID INVERTER



Contents

Thank you for choosing AUSTA Hybrid inverter. In order to ensure your safety and proper use, please read the manual in details before using. Thanks for your cooperation!

1. INTRODUCTION	1
1.1 Safety & Warning	1-2
1.2 Product overview	2-3
2. INSTALLATION INSTRUCTIONS	4
2.1 Unacceptable installations	4
2.2 Packing list	4
2.3 Mounting	5
2.3.1 Select Mounting Location	5
2.3.2 Mounting	5
2.4 Electrical Wiring Connection	6
2.4.1 Pv Connection	6
2.4.2 Battery Connection	6-7
2.4.3 On-grid & Back-up Connection	7-10
2.5 Single Phase Parallel Connection Diagram	11
3. MANUAL OPERATION	12
3.1 Smart Setapp Operation	12
3.2 Single Phase Parallel Parameter Settings	12
3.3 Operation Modes Introduction	12-13
3.4 Daily Operation and Maintenance	13
4. TROUBLE SHOOTINGS	14
4.1 Warning List	14-15
4.2 Fault Reference Codes	15-18
4.3 Troubleshootings	18--20
5. OTHERS	21
5.1 Disclaimer	21-22
5.2 Technical Parameters	22-23

1 INTRODUCTION

Hybrid inverter series, also called hybrid or bidirectional solar inverters, apply to solar system with participation of PV, battery, loads and grid system for energy management.

The energy produced by PV system shall be used to optimize self-consumption, excess power charge battery and the rest power could be exported to the grid.

Battery shall discharge to support loads when PV power is insufficient to meet self-consumption. If battery power is not sufficient, the system will take power from grid to support loads.

Note: the introduction describes a general behavior of Hybrid inverter system. The operation mode can be adjusted on APP based on the system layout. Below are the general operation modes for system.



1.1 Safety & Warning

Please read and follow all the instructions and cautions on the inverter or user manual during installation, operation or maintenance, as any improper operation might cause personal or property damage.

• Symbols Explanation

	Caution! Failing to observe a warning indicated in this manual may result in injury.
	DANGER High voltage hazard. Disconnect all incoming power and turn off the product before working on it.
	Danger of hot surface! High-temperature hazard. Do not touch the product under operation to avoid being burnt.
	This side up! The package must always be transported, handled and stored in such away that the arrows always point upwards.
	Product should not be disposed as household waste. Do not dispose of the inverter as household waste. Discard the product in compliance with local laws and regulations .or send it back to the manufacturer.
	Grounding point.
	Read through the user manual before any operations.
	Keep dry! The package/product must be protected from excessive humidity and must be stored under cover.
	Inverter will be touchable or operable after minimum 5 minutes of being turned off or totally disconnected, in case of any electrical shock or injury.

• Safety Warning

Any installation and operation on inverter must be performed by qualified electricians, in compliance with standards, wiring rules or requirements of local grid authorities or companies.

Before any wiring connection or electrical operation on inverter, all DC and AC power must be disconnected from inverter for at least 5 minutes to make sure inverter is totally isolated to avoid electric shock.

The temperature of inverter surface might exceed 60 °C during working, so please make sure it is cooled down before touching it, and make sure the inverter is untouchable for children.

Do not open inverter cover or change any components without authorization, otherwise the warranty commitment for the inverter will be invalid.

Usage and operation of the inverter must follow instructions in this user manual, otherwise the protection design might be useless and warranty for the inverter will be invalid.

Appropriate methods must be adopted to protect inverter from static damage. Any damage caused by static is not warranted by manufacturer.

PV negative (PV-) on inverter side is not grounded as default design.

The total open-circuit voltage of PV string/array is lower than the maximum rated DC input voltage of the inverter. Any damage caused by PV over-voltage is beyond warranty.

Leakage protection switches are not recommended between the inverter and the grid.



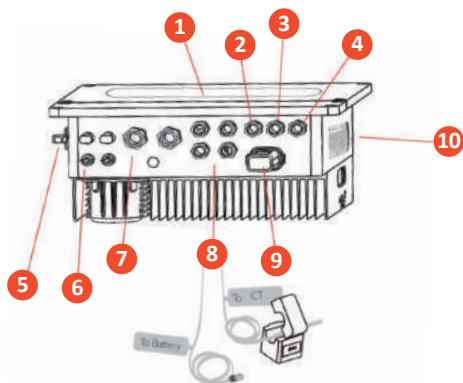



















1.2 Product Overview



1	LED panel
2	Gen /Back Up2
3	Back Up1
4	On-Grid
5	DC Switch (Optional)
6	PV Terminals
7	Battery Terminals
8	CT Communication Cable
9	Wi-Fi
10	Led Indicators

• Led Indicators

Indicator	Status	Explanation
System		On = system is ready
		Blink = system is starting up
		Off = system is not operating
Back-Up		On = back-up is ready /power available
		Off = back-up is off/ no power available
Com		On = bms and meter communication ok
		Blink1 = meter communication ok, bms communication fail
		Blink2 = bms communication ok, meter communication fail
		Off = bms and meter communication fail

Indicator	Status	Explanation
 Battery		On = battery is charging
		Blink 1= battery is discharging
		Blink 2= battery is low/soc is low
		Off = battery is disconnected/not active
 Grid		On = grid is active and connected
		Blink = grid is active but not connected
		Off = grid is not active
 Energy		On = consuming energy from grid /buying
		Blink 1= supplying energy to grid/zeroing
		Blink 2= supplying energy to grid selling
		Off = grid not connected or system not operating
 Wi-Fi		On = Wi-Fi connected /active
		Blink 1= Wi-Fi system resetting
		Blink 2 = Wi-Fi not connect to router
		Blink 4 = Wi-Fi server problem
 Fault		On = fault has occurred
		Blink = overload of back-up output reduce load
		Off = no fault

2 INSTALLATION INSTRUCTIONS

2.1 Unacceptable Installations

Please avoid the following installations, which will damage the system or the inverter.

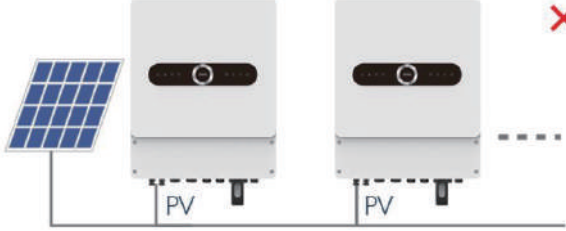
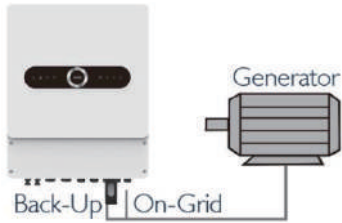
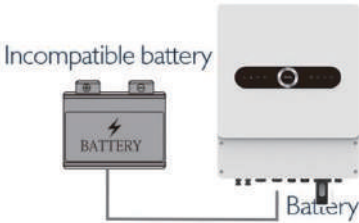
	
<p>BACK-UP SIDE CANNOT CONNECT TO GRID.</p>	<p>SINGLE PV STRING CANNOT CONNECT TO TWO OR MORE INVERTERS.</p>
	
<p>ON-GRID OR BACK-UP SIDE CANNOT CONNECT TO ANY AC GENERATOR.</p>	<p>CANNOT COMMUNICATE TO INCOMPATIBLE BATTERIES.</p>

2.2 Packing List

On receiving the inverter, please check to make sure all the components as below are not missing or broken.

					
<p>Inverter*1</p>	<p>Wall-mounted Bracket*1</p>	<p>CT*1</p>	<p>Data Collector*1</p>	<p>Positive DC Plug*2</p>	<p>Negative DC Plug*2</p>
					
<p>Net cable*1</p>	<p>Battery terminal*2</p>	<p>Expansion Bolts*2</p>	<p>Hexagon head screw*2</p>	<p>Cold terminals*9</p>	<p>Hexagon head screw*2</p>

2.3 Mounting

2.3.1 Select Mounting Location

For inverter's protection and convenient maintenance, mounting location for inverter should be selected carefully based on the following rules:

Rule 1. Inverter should be installed on a solid surface, where is suitable for inverter's dimensions and weight.

Rule 2. Inverter installation should stand vertically or lie on a slope by max 15°.



Rule 3. Ambient temperature should be lower than 60°C

Rule 4. The installation of inverter should be protected under shelter from direct sunlight or bad weather like snow, rain, lightning etc.

Rule 5. Inverter should be installed at eye level for convenient maintenance.

Rule 6. Product label on inverter should be clearly visible after installation.

Rule 7. Leave enough space around inverter following the values on pic 3.

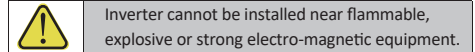
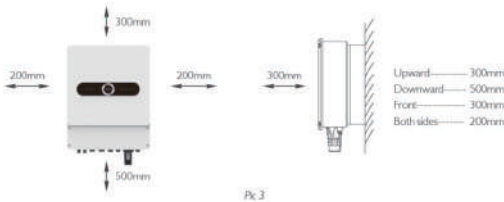

Inverter cannot be installed near flammable, explosive or strong electro-magnetic equipment.

2.3.2 Mounting

The inverter is suitable for mounting on concrete or other non-combustible surface only.

	<p>Step1: Please use the mounting bracket as a template to drill 2 holes on right positions (10mm in diameter, and 35mm in depth) Use expansion bolts in accessory box and fix the mounting bracket onto the wall tightly.</p> <p>NOTE: Bearing capacity of the wall must be higher than 20KG, otherwise may not be able to keep inverter from dropping.</p>
	<p>Step2: Carry the inverter by holding the heating sink on two sides and Place the inverter on the mounting bracket.</p> <p>NOTE: Make sure the heat sink on inverter is rightly joint with mounting bracket.</p>
	<p>Step3: Finally, screw fixation, both screws need to be fixed. Add anti-theft locks as needed.</p> <p>NOTE: Make sure the screws between the inverter and the fixing plate are fixed tightly shedding.</p>
	<p>Step4: Ground cable shall be connected to ground plate on grid side .</p>



2.4 Electrical Wiring Connection

2.4.1 Pv Connection

Before connecting PV panels/strings to inverter, please make sure requirements are followed as below :

- The total short-circuit current of PV string must not exceed inverter's max DC current
- The minimum isolation resistance to ground of the PV string must exceed 33kΩ in case of any shock hazard
- PV strings could not connect to earth/grounding conductor
- Use the DC plugs in the accessory box

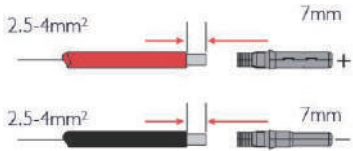
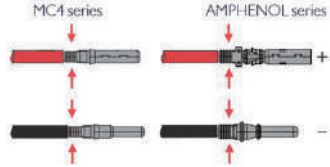
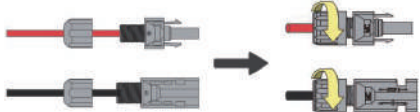
NOTE: There will be MC4 or Amphenol DC plugs in accessory box, the detailed connection as below:

<p>Step1: Prepare PV cables and DC plugs.</p>  <p>NOTE:</p> <ul style="list-style-type: none"> • Please use DC plugs and connectors in accessory box. • PV cable should be standard, 2.5-4mm2 PV cable. 	<p>Step2: Connect PV cable to DC connectors.</p>  <p>NOTE:</p> <ul style="list-style-type: none"> • PV cable must be tightly crimped into the Connectors. • For Amphenol connector, the limit buckle cannot be pressed.
<p>Step3: Screw the cap on and plug onto inverter side.</p>  <p>NOTE:</p> <ul style="list-style-type: none"> • There will be a click sound if connectors are inset correctly into DC plugs. <div style="border: 1px solid black; padding: 5px; display: inline-block;">  <p>The polarity of PV strings or on the inverter cannot be connected by reverse, otherwise inverter could be damaged.</p> </div>	

2.4.2 Battery Connection

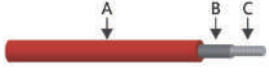

For lithium battery (pack) the capacity should be 50Ah or larger. Battery cable requirement as below.

	Grade	Description	Value
	A	OD	10-12mm
	B	Isolation section	NA
	C	Conductor Core	16-25mm ²

NOTE:

- Please be careful against any electric shock or chemical hazard

• **Battery wiring connection steps as below:**

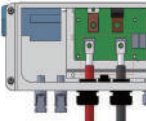
 <p>Make sure battery switch is off and battery nominal voltage meet Hybrid inverter specification before connecting battery to inverter make sure inverter is totally isolated from PV and AC power.</p>	
<p>Step1: Prepare battery cables and accessories and put battery power cable through battery cover.</p>  <p>NOTE:</p> <ul style="list-style-type: none"> • Please use accessories from box. • Battery power cable should be 16-25mm². 	<p>Step2: Make battery terminals.</p>  <p>NOTE:</p> <ul style="list-style-type: none"> • Strip cable coat, revealing 10mm length of metal core. • Use special crimper to compress battery terminal tightly.
<p>Step3: Screw the cap on and plug onto inverter side.</p>  <p>NOTE:</p> <ul style="list-style-type: none"> • Please make sure polarity (+/-) of battery are not reversed. 	

• **For lead-acid batteries**

Lead-Acid and other similar older-technology battery types require experienced and precisedesign, installation and maintenance to work effectively.

For lead-acid battery bank, the inconformity between battery cells might lead to battery cellover-charge or discharge, and further might damage battery cells and shorten battery bank life.

For this series inverters there is no temperature compensation, thus customers need dobattery settings based on the real working temperature of battery.

For lead-acid battery settings on App, please honestly refer to battery specifications and the actually battery work condition like work temperature and battery age. Unsuitable settings will lead to higher SOC deviation, weaker battery lifespan and further battery damage.

For lead-acid batteries, there is no communication with the inverter, and the sOC of the battery is not counted.

We will keep the right for explanation on all the settings suggested and all the problems happened on lead-acid batteries or the whole system. And we are not responsible for any damage caused by unsuitable settings, battery beyond warranty or battery quality etc.

• **Battery protection description**

Battery will act a protective charge/discharge current limitation under any condition as below:

- Battery SOC is lower than I-DOD
- Battery voltage lower than discharge voltage
- Battery over temperature protection
- Battery communication abnormal for lithium battery
- BMS limitation for lithium battery

When charge/discharge current limitation protection happens:

- Under on-grid mode, battery charge/discharge operation could be abnormal
- Under off-grid mode, Back-Up supply will shut down

NOTE

Under off-grid mode, if Back-Up supply shuts off because of battery of low battery SOC PV power will all be used to charge battery till battery SOC reaches 10%(adjustable);

Under on-grid mode , battery is protected from over discharge by 40% less than SOC Protection, resume discharge by 50% more than SOC Protection; Battery is protected from over discharge by setting Cut-off Voltage, resume discharge by 52V (adjustable).

2.4.3 On-grid & Back-up Connection

An external AC switch (>32A) is needed for On-Grid connection to isolate from grid when necessary. Below are the require-ments on AC switch use:

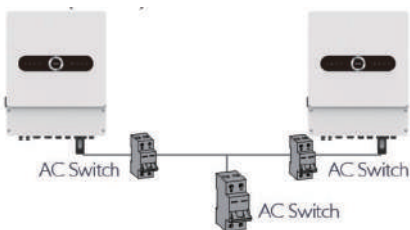

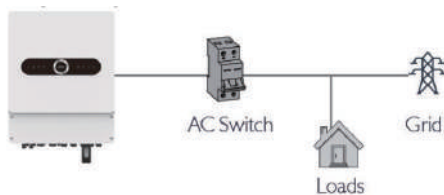

1. Use a separate AC switch for individual inverter.



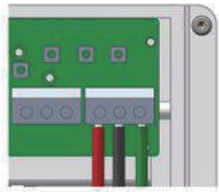

2. On AC side, the individual switch should be connected before loads (between inverter and loads).

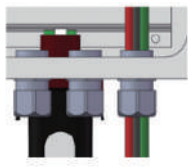
• **On-Grid wiring connection process is as below :**

<p>Step1: 1. Prepare the terminals and AC cables. 2. Put AC cable through terminal cover and screw the three cables tightly on the connectors.</p>  <p>4-6mm² Copper Conductor Material</p> <p>NOTE:</p> <ul style="list-style-type: none"> • Please use the terminals in components box. • Make sure cable jacket is not locked with conductor. 	<p>Step2: Lock terminal cover and screw up the terminal cap</p>  <p>NOTE:</p> <ul style="list-style-type: none"> • Make sure the terminal cover is rightly locked onto the terminal. <div style="border: 1px solid black; padding: 5px; margin-top: 10px;">  <p>Make sure inverter is totally isolated from any DC or AC power before connecting AC Cable.</p> </div>
<p>Step3: Connect the assembled AC terminals onto inverter.</p>  <p>NOTE:</p> <ul style="list-style-type: none"> • Make sure it is connected to 'On-Grid' side (other side connected to public grid). 	

• **Back-Up wiring connection process is as below:**

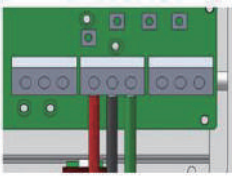
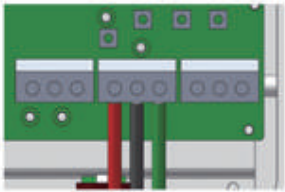
An external AC switch (>32A) is needed for Back-Up connection to be isolated when necessary.

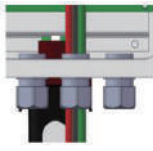
<p>Step1: 1. Prepare the terminals and AC cables. 2. Put AC cable through terminal cover and screw the three cables tightly on the connectors.</p>  <p>4-6mm² Copper Conductor Material</p> <p>NOTE:</p> <ul style="list-style-type: none"> • Please use the terminals in components box. • Make sure cable jacket is not locked with conductor. 	<p>Step2: Lock terminal cover and screw up the terminal cap</p>  <p>NOTE:</p> <ul style="list-style-type: none"> • Make sure the terminal cover is rightly locked onto the terminal. <div style="border: 1px solid black; padding: 5px; margin-top: 10px;">  <p>The absence of AC breaker on Back-Up side will lead to inverter damage if only electrical short-circuit happens on Back-Up side. And Back-Up function cannot turn off under on-grid condition.</p> </div>
<p>Step3: Connect the assembled AC terminals onto inverter.</p>  <p>NOTE:</p> <ul style="list-style-type: none"> • Make sure it is connected to 'back-up' side 	

Intelligent management of back up

The inverter supports dual back up output in off-grid mode, and you can remotely adjust the energy regulation of each back up; connecting with lead-acid battery, it supports remote voltage regulation.

Declaration For Back-Up Overload Protection

Inverter will restart itself as overload protection happens. The preparation time for restarting will be longer and longer (max one hour) if overload protection repeats. Take following steps to restart inverter immediately: Decrease Back-Up load power within max limitation.

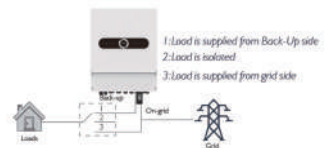

• Ct indications

Since this product is a split type transformer, please pay attention to the cleanliness of the magnetic core surface during installation. If there is dirt on the core surface, the accuracy of the product will be deteriorated.

1. Before the transformer is connected to any equipment, please ensure that the circuit is powered off to prevent clicks.
2. Open CT, see figure 1.
3. Clip the CT on the cable under test. Make sure that the maximum current in the wiring does not exceed the maximum input current of the CT; The current flows in the direction of the arrow on the CT housing.
4. Fasten the CT again, the cable under test should be inside the CT window now (see figure 2)
5. Fix the CT on the cable under test with nylon cable ties to prevent the CT from sliding see figure 3)
6. Connect the CT output white wire to the positive terminal of the measuring device, and the CT output black wire to the negative terminal of the measuring device (see figure 4).
7. After checking that the circuit is correct, turn on the power and the CT starts to measure the current in the circuit.

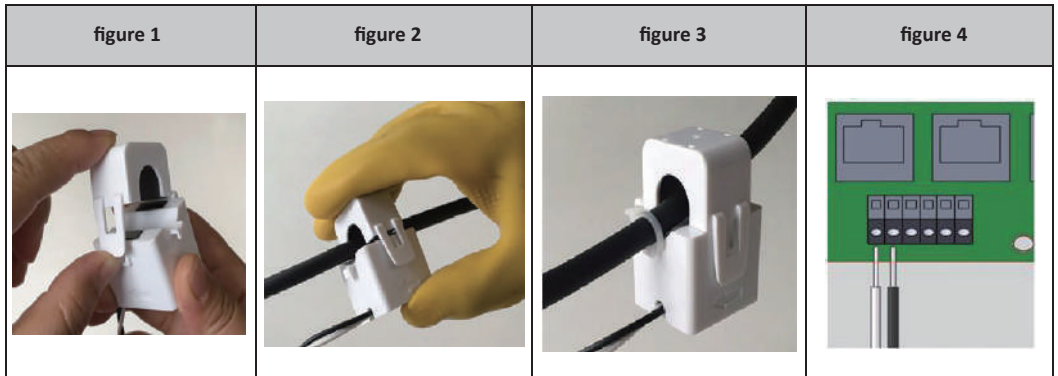

All work should be performed by trained and qualified operators using safe and suitable tools.

• Wiring system for hybrid inverter

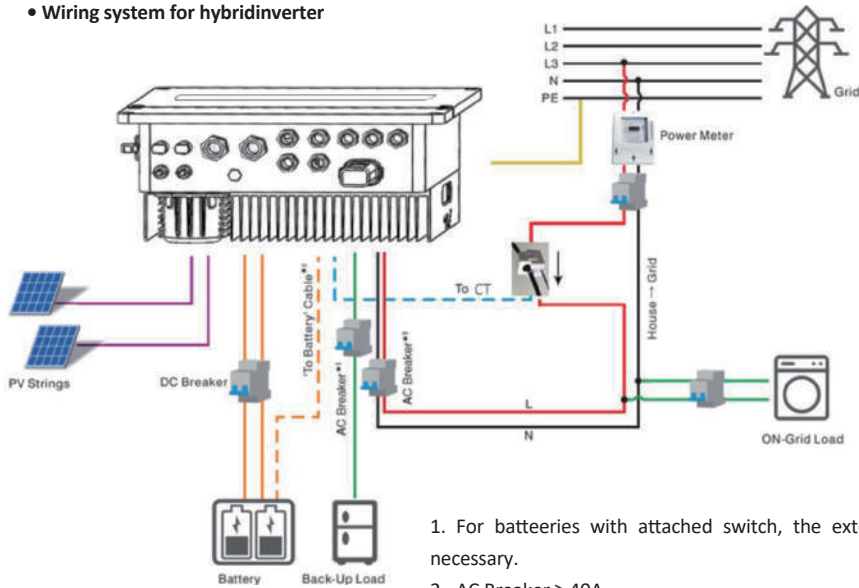

• System connection diagrams

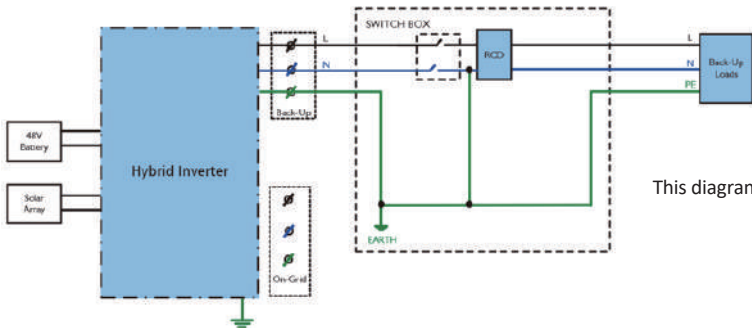

This diagram is an example for off-grid system

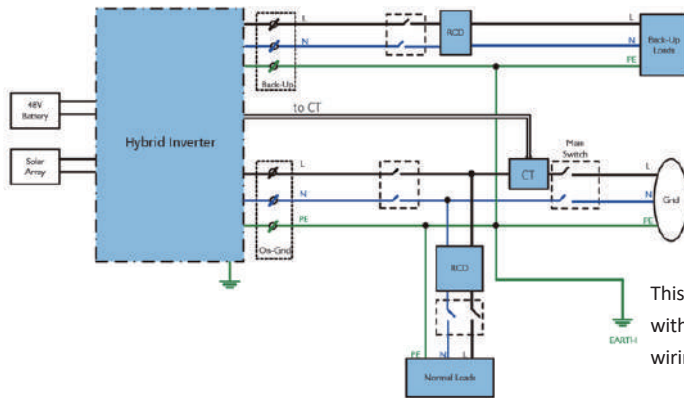

This diagram is an example for grid system without special requirement on electrical wiring connection

NOTE

Meter communication cable (RJ45) is attached on the inverter "To Meter" cable, could be extended to max 100m, and must use standard RJ45 cable and plug as below:

Position	Color	BMS(CAN)Function	BMS(485)Function	Meter Function
1	Orange&white	NC	485_B	NC
2	Orange	NC	485_A	NC
3	Green&white	NC	NC	485_BI
4	Blue	CAN_H	NC	NC
5	Blue&white	CAN_L	NC	NC
6	Green	NC	NC	485_AI
7	Brown&white	NC	485_A	485_BI
8	Brown	NC	485_B	485_AI



2.5 Single Phase Parallel Connection Diagram

CAN L wire N wire PE wire CT wire

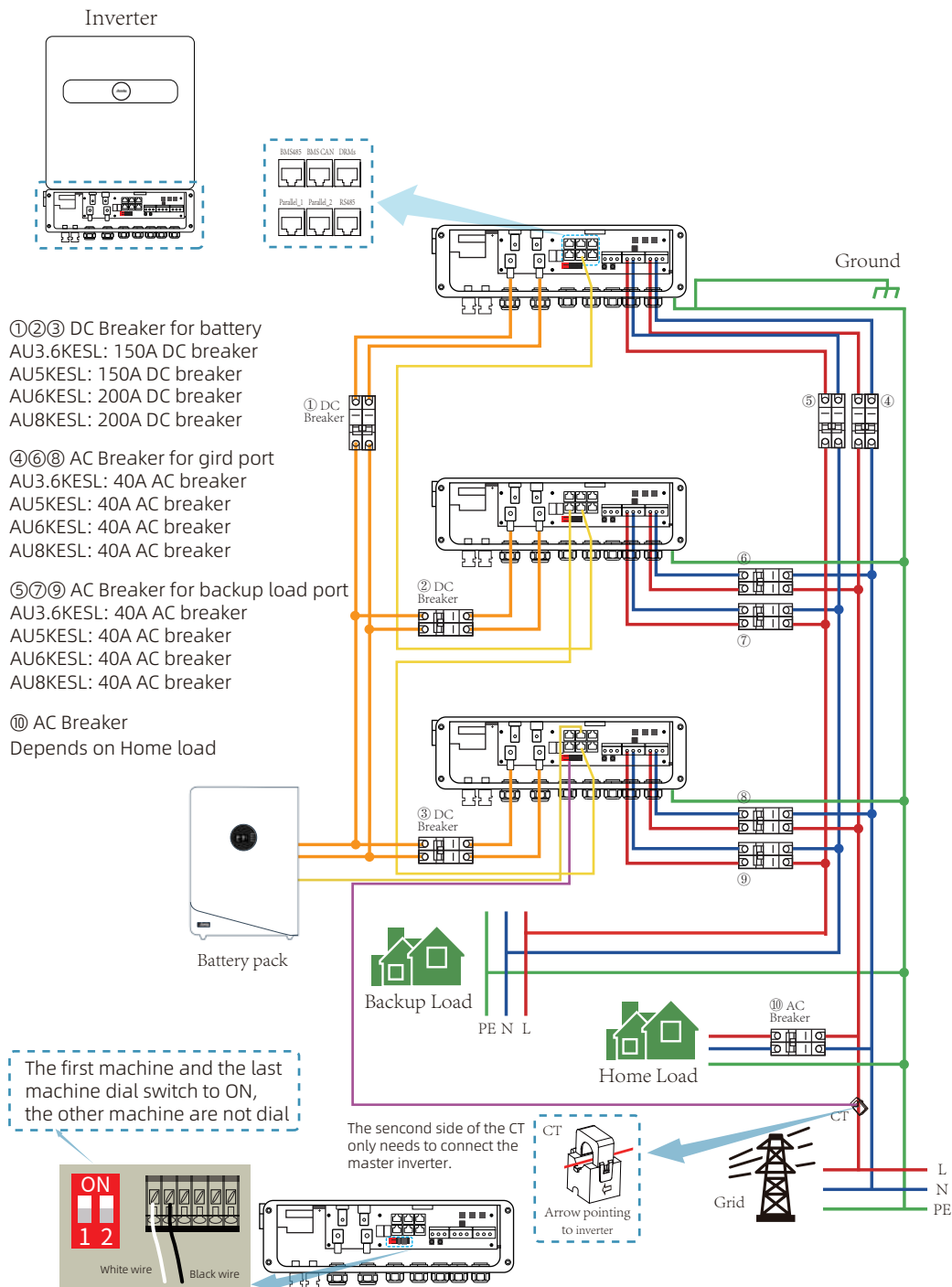

3.1 Smart SetApp Operation

During the initial installation, you can download and install the Smart Set app on your smartphone, allowing you to configure the installation of the hybrid inverter more easily.

- Edit system configuration to make the system work as customer needs
- Monitor and check performance of the hybrid system
- Wi-Fi configuration

Please download Smart SetApp



iphone :
Search "Smart Set App "in Apple Store



Android:
Search "Smart SetApp" in Google Play

NOTE: You must install in an uninterrupted Wi-Fi environment.

3.2 Initial Installation Setup



3.3 Operation Modes Introduction

Hybrid inverter system normally has the following work modes based on your configuration and layout conditions.

General mode	
<p style="text-align: center;">Daytime</p>	<p style="text-align: center;">At night</p>
<p>In this mode, the load supply priority is PV> Grid mains > Battery.</p> <ol style="list-style-type: none"> 1. When PV power is available, PV power will provide power to the load first. If it's sufficient, PV power will charge the battery, if it's more sufficient, PV power will feed-in to the grid. 2. When PV power is not available or not sufficient, the grid mains will provide power to the load. 3. When PV power and the grid mains is not available, the battery will provide power to the load. 	
NOTE	
<p>In this mode, only the PV power can charge the battery, and the battery can only provide power to the load and can't provide power to feed-in the grid.</p>	

Off-grid mode

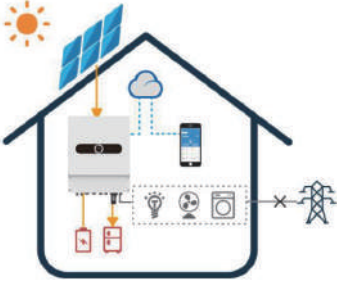

In this mode, the load supply priority is PV > Battery.
In this mode, the inverter will provide 230V pure sine waveform to ensure the load can use pure electricity.

1. When PV power is available, provide 230V pure sine waveform to ensure the load.
2. When PV power is not available or not sufficient, the battery will provide power to the load.

NOTE

In this mode, only the PV power can charge the battery. to ensure the load can use pure electricity, the grid mains is not available.

Economical mode

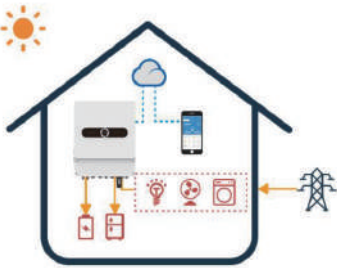

In this mode, you can set a set of battery charging and discharging time.

(1) During the battery charging period:

1. When PV power is available, PV power will provide power to the load first. If it's sufficient, PV power will charge the battery, if it's more sufficient, PV power will feed-in to the grid.
2. When PV power is not available or not sufficient, the grid mains will provide power to the load and charge the battery at the meanwhile.

NOTE: In this mode, the grid mains can charge the battery. So we suggest that the charging period is setting in the electricity valley time.

(2) During the battery discharging period:

1. When PV power is available, PV power will provide power to the load first. If it's sufficient, PV power will feed-in to the grid directly.
2. When PV power is not available or not sufficient, the battery will provide power to the load.
3. When the battery voltage is under the cut-off voltage, the grid mains will provide power to the load.

3.4 Daily Operation and Maintenance



iphone :
Search "Austa Solar "in Apple Store



Android:
Search "Austa Solar" in Google Play

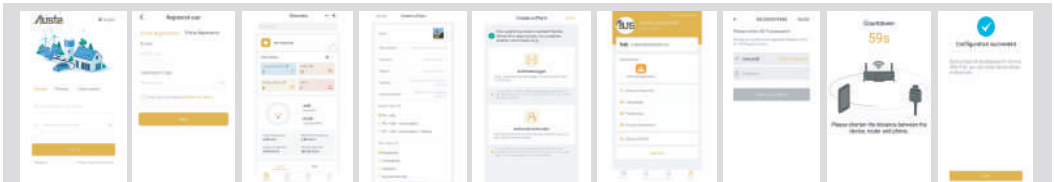

4.1 Warning List

System Warning Code 1	Warning Event	Description	Solutions
0	Over Ugrid	The Grid Voltage is Higer than the setting value when the inverter is running	<ol style="list-style-type: none"> 1. Check the AC voltage is in the range of standard voltage inspecification; 2. Check whether grid AC cables are firmly and correctly connected; 3. If the error message still remains, please contact your installer.
1	Under Ugrid	The Grid Voltage is Lower than the setting value when the inverter is running	<ol style="list-style-type: none"> 1. Check the AC voltage is in the range of standard voltage inspecification; 2. Check whether grid AC cables are firmly and correctly connected; 3. If the error message still remains, please contact your installer
2	Over Fr	The Grid Frequency is Higer than the setting value when the inverter is running	<ol style="list-style-type: none"> 1. Check the frequency is in the range of specification or not; 2. Check whether AC cables are firmly and correctly connected; 3. If the error message still remains, please contact your installer.
3	Under Fr	The Grid frequency is Lower than the setting value when the inverter is running	<ol style="list-style-type: none"> 1. Check the frequency is in the range of specification or not; 2. Check whether AC cables are firmly and correctly connected; 3. If the error message still remains, please contact your installer.
4	Line Check	The Grid is Loss when the inverter is running	<ol style="list-style-type: none"> 1. Check whether grid AC cables are firmly and correctly connected; 2. Restart the inverter 2-3 times; 3. if the fault still existing, please contact us for help.
5	Under Upv	The PV voltage is lower than 120V when turn on the PV switch	<ol style="list-style-type: none"> 1. Check the PV is in the range of specification or not; 2. Check whether PV cables are firmly and correctly connected; 3. If the error message still remains, please contact your installer.
6	Reserved		
7	Reserved		
8	Reserved		
9	Reserved		
10	Reserved		
11	Reserved		
12	Reserved		
13	Reserved		
14	Reserved		
15	Reserved		

System Warning Code 2	Warning Event	Description	Solutions
0	UBATTERY_LOW	The battery voltageis lower than 44V orlower than the SOCthat you setting	<ol style="list-style-type: none"> 1. Check the battery voltage; 2. Check whether Battery cables are firmly and correctly connected; 3. Restart the inverter 2-3 times; 4. if the fault still existing, Please contact your installer.
1	UBATTERY_LOSS	The battery is lower than 25V	<ol style="list-style-type: none"> 1. Check the battery voltage; 2. Check whether Battery cables are firmly and correctly connected; 3. Restart the inverter 2-3 times; 4. if the fault still existing, Please contact your installer.

2	Reserved		
3	Reserved		
4	Fault FAN	The FAN isn't working	1. Restart the inverter 2-3 times; 2. if the fault still existing, Please contact your installer.
5	Reserved		
6	Battery Transient under voltage	The battery voltage is lower than 40V at one moment	1. Check the battery voltage; 2. Check whether Battery cables are firmly and correctly connected; 3. Restart the inverter 2-3 times; if the fault still existing, Please contact your installer.
7	Reserved		
8	Reserved		
9	DC Stop	The DC side isn't working	1, The BUS voltage can't be built from PV or battery. 2. Check whether Battery cables are firmly and correctly connected; 3. Restart the inverter 2-3 times; 4. if the fault still existing, Please contact your installer.
10	Reserved		
11	Reserved		
12	Reserved		
13	Reserved		
14	Reserved		
15	Reserved		

4.2. Fault Reference Codes

System Fault Code 1	Fault Event	Description	Solutions
0	Under Upv1	The PV voltage is lower than 20V ,and the current is higher than 2A	1. Check the PV is in the range of specification or not; 2. Check whether PV cables are firmly and correctly connected; 3. If the error message still remains, please contact your installer.
1	Over Ipv1	The PV current is higher than 30A	DC side over current fault 1. Check PV module connect and battery connect; 2. Turn off the DC switch and AC switch and then wait one minute, then turn on the DC/AC switch again; 3. If the error message still remains, please contact your installer.
2	Over Upv1	The PV voltage is higher than 500V	1. Check the PV is in the range of specification or not; 2. Check whether PV cables are firmly and correctly connected; 3. If the error message still remains, please contact your installer.
3	Over Ipv2	The PV current is higher than 30A	DC side over current fault 1. Check PV module connect and battery connect; 2. Turn off the DC switch and AC switch and then wait one minute, then turn on the DC/AC switch again; 3. If the error message still remains, please contact your installer.
4	Over temp	The temperature is higher than 100℃	1. Check whether the work environment temperature is too high; 2. Turn off the inverter for 10mins and restart; 3. if the fault still existing, please contact us for help.
5	Over Iac	AC over current fault	AC side over current fault 1. Please check whether the backup load power and common load power are within the range; 2. Restart and check whether it is in normal;

			<ol style="list-style-type: none"> 3. Check the backup load connected, make sure it is in allowed power range. 4. If the fault still exists, please contact us for help. 5. If the error message still remains, please contact your installer.
6	Over Ugrid	The Grid Voltage is Higer than the setting value when the inverter isn't running	<p>Grid voltage fault</p> <ol style="list-style-type: none"> 1. Check the AC voltage is in the range of standard voltage inspecification; 2. Check whether grid AC cables are firmly and correctly connected; 3. If the error message still remains, please contact your installer.
7	Over Fr	The Grid Frequency is Higer than the setting value when the inverter isn't running	<p>Grid frequency out of range</p> <ol style="list-style-type: none"> 1. Check the frequency is in the range of specification or not; 2. Check whether AC cables are firmly and correctly connected; 3. If the error message still remains, please contact your installer
8	Under Backup	The backup is connected with the Grid	<ol style="list-style-type: none"> 1. Check the backup terminal; 2. Detect the backup voltage with the multimeter; 3. Restart the inverter 2-3 times; 4. if the fault still existing, please contact us for help.
9	Over Ubus	The BUS Voltage is Higer than 560V	<ol style="list-style-type: none"> 1. check the total power of the inverter; 2. Restart the inverter 2-3 times; 3. if the fault still existing, please contact us for help.
10	Over Ileak	AC leakage current fault	<p>Leakage current fault</p> <ol style="list-style-type: none"> 1. Check the PV side cable ground connection; 2. Restart the inverter 2-3 times; 3. if the fault still existing, please contact us for help.
11	Fault Relay	The Relay isn't working	<ol style="list-style-type: none"> 1. Restart the inverter 2-3 times; 2. if the fault still existing, please contact us for help.
12	Fault GFD	DC insulation failure	<p>PV isolation resistance is too low</p> <ol style="list-style-type: none"> 1. Check the connection of PV panels and inverter is firmly and correctly; 2. Check whether the PE cable of inverter is connected to ground; 3. If the error message still remains, please contact your installer.
13	Over Backup Voltage	The Backup Voltage is high	<ol style="list-style-type: none"> 1. Check the backup terminal; Detect the backup voltage with the multimeter; 2. Restart the inverter 2-3 times; 3. if the fault still existing, please contact us for help.
14	XINT Iac	The inverter current is high and touch the protection.	<ol style="list-style-type: none"> 1. check the power of the backup load; 2. Restart the inverter 2-3 times; 3. if the fault still existing, please contact us for help.
15	Remote Shutdown	Turn off the inverter	<ol style="list-style-type: none"> 1. Check the other fault code of the inverter and according to the solution to solve the problem. 2. Restart the inverter 2-3 times; 3. if the fault still existing, please contact us for help.

System Fault Code 2	Fault Event	Description	Solutions
0	Fault SPI	The upper computer communicates with the lower computer fault	<ol style="list-style-type: none"> 1. Restart the inverter 2-3 times; 2. if the fault still existing, please contact us for help.
1	Under Ugrid	The Grid Voltage is Lower than the setting value when the inverter isn't running	<p>Grid voltage fault</p> <ol style="list-style-type: none"> 1. Check the AC voltage is in the range of standard voltage inspecification; 2. Check whether grid AC cables are firmly and correctly connected; 3. If the error message still remains, please contact your installer.

2	Under Fr	The Grid Frequency is Lower than the setting value when the inverter isn't running	Grid frequency out of range 1. Check the frequency is in the range of specification or not; 2. Check whether AC cables are firmly and correctly connected; 3. If the error message still remains, please contact your installer.
3	Under Upv2	The PV voltage is lower than 20V ,and the current is higher than 2A	1. Check the PV is in the range of specification or not; 2. Check whether PV cables are firmly and correctly connected; 3. If the error message still remains, please contact your installer.
4	Over Upv2	The PV voltage is higher than 500V	1. Check the PV is in the range of specification or not; 2. Check whether PV cables are firmly and correctly connected; 3. If the error message still remains, please contact your installer.
5	Reserved		
6	Under Ubus	The BUS Voltage is Lower than 300V	1. check the total power of the inverter; 2. Restart the inverter 2-3 times; 3. if the fault still existing, please contact us for help.
7	Reserved		
8	Fault Temper	The Temper is fault	1. Check whether the work environment temperature is too high or too low; 2. Turn off the inverter for 10mins and restart; 3. if the fault still existing, please contact us for help.
9	Over Load	The Relay isn't working	1. check the total power of the inverter; 2. Restart the inverter 2-3 times; 3. if the fault still existing, please contact us for help.
10	Reserved		
11	Parallel Data Loss	Parallel Data Loss	1. When in parallel mode, check the parallel communication cable connection and hybrid inverter communication address setting; 2. Restart the inverter 2-3 times; 3. If the fault still exists, please contact us for help.
12	Parallel Phase Loss	Parallel Phase Loss	1. When in parallel mode, check the parallel communication cable connection and hybrid inverter communication address setting; 2. Restart the inverter 2-3 times; 3. If the fault still exists, please contact us for help.
13	Parallel Stop	Parallel system stop	1. Check the hybrid inverter work status. According to the fault code to solve the problem. 2. if the fault still existing, please contact us for help.
14	XINT Ipv	The PV boost current is high and touch the protection.	1. check the PV voltage and the power of the backup load; 2. Restart the inverter 2-3 times; 3. if the fault still existing, please contact us for help.
15	Reserved		

System Fault Code 3	Fault Event	Description	Solutions
0	UBUS_OVER	The BUS Voltage is Higer than 560V	1. check the total power of the inverter; 2. Restart the inverter 2-3 times; 3. if the fault still existing, please contact us for help.
1	UBUS_LOW	The BUS Voltage is Lower than 300V	1. check the total power of the inverter; 2. Restart the inverter 2-3 times; 3. if the fault still existing, please contact us for help.

2	UBATTERY_OVER	The Battery Voltage is Higer than 60V	1. Check the battery voltage; 2. Restart the inverter 2-3 times; 3. if the fault still existing, please contact us for help.
3	Reserved		
4	ILLC_OVER	The LLC current is high	1. check the total power of the inverter include the charging and the discharging current; 2. Restart the inverter 2-3 times; 3. if the fault still existing, please contact us for help.
5	IBuckBoost_OVER	The Buck-boost voltage is high and touch the protection	1. check the total power of the inverter include the charging and the discharging current; 2. Restart the inverter 2-3 times; 3. if the fault still existing, please contact us for help.
6	ULLC_OVER	The LLC voltage is high and touch the protection	1. check the total power of the inverter include the charging and the discharging current; 2. Check the battery voltage; 3. Restart the inverter 2-3 times; 4. if the fault still existing, please contact us for help.
7	Fault data SPI	The upper computer communicates with the lower computer fault	1. Restart the inverter 2-3 times; 2. if the fault still existing, please contact us for help.
8	Over time SPI	The upper computer communicates with the lower computer fault	1. Restart the inverter 2-3 times; 2. if the fault still existing, please contact us for help.
9	Over Ibat	The battery current is higher than 1.5 multiples of the setting value	1. check the discharging current that you setting; 2. check the total power of the inverter; 3. if the fault still existing, please contact us for help.
10	Reserved		
11	Reserved		
12	Reserved		
13	Reserved		
14	ILLC_XINT	The LLC current is high and touch the protection	1. check the total power of the inverter include the charging and the discharging current; 2. Restart the inverter 2-3 times; 3. if the fault still existing, please contact us for help.
15	IBuckBoost_XINT	The Buck-boost current is high and touch the protection	1. check the total power of the inverter include the charging and the discharging current; 2. Restart the inverter 2-3 times; 3. if the fault still existing, please contact us for help.

4.3 Troubleshootings

• Troubleshootings

Checking before starting up

- PV Input Connection: Confirm the connection between inverter and PV panels : polarity (+/-)not reversed.
- Battery Connection: Confirm the connection between inverter and battery : polarities (+/-) not reversed.
- On-Grid & Back-Up Connection: Confirm On-Grid connected to public grid and Back-Up to loads : polarity (L/N) not reversed.

Problems During Operation

Hybrid inverter not start up with only battery

Solution:

1. Make sure the voltage of battery is higher than 48V, otherwise battery cannot start Hybrid inverter up.

Hybrid inverter not start up with only PV

Solution:

1. Make sure the voltage of PV is higher than 150V
2. Make sure that connection between Hybrid inverter and PV panels : polarities (+/-) not reversed.

No discharge or output from hybrid inverter at night without PV or PV power lower than load power:

Solution:

1. Communication between Hybrid inverter and Meter is OK or not;
2. Make sure load power is higher than 150W.
 - a. battery will not discharge continuously unless load power is higher than 150W;
 - b. If battery still not discharge when Meter power is higher than 150W, then please check Meter connection and direction:

Battery not charge when pv power higher than load power:

Solution:

1. Check if charge voltage on App (Set→Basic Setting) is properly set (for lead-acid battery) as battery cannot charge if battery voltage reaches charge voltage.
2. Check if it is during discharge time set on App.
3. Check if battery is fully charged or not, or battery voltage reach "charge voltage" or not.

High power fluctuation battery charge or discharge:

Solution:

- Check if there is a fluctuation on load power:
1. Check if there is a fluctuation on PV power.

Battery does not charge

Solution:

1. Make sure BMS communication is OK on App .
2. Check if the total load power is much higher than PV power.

Questions & Answers (Q & A)

About Wi-Fi configuration

Q: Why cannot see Solar-WiFi signal on mobile devices?

A: Normally Solar-WiFi signal could be searched right after inverter powered up. But Solar-WiFi signal will disappear when Hybrid inverter connected to internet, if need change settings, can connect to the router to change. If cannot see WiFi signal even not connect to router, then please try to reload WiFi.

About battery operation

Q: Why battery does not discharge when grid is not available, while it discharge normally when grid is available?

A: On APP Of-Grid Output and backup function should be turned on to make battery discharge under off-grid mode.

Q: Why there is output on Back-Up side?

A: For Back-Up supply, the "Back-Up Function" on App must be turned on. Under off-grid mode or grid power is disconnected, "Off-Grid Out" function must be turned on as well.

NOTE: As turn "Off-Grid Output" on, don't restart inverter or battery, otherwise the function will switch off automatically.

Q: Why battery switch always trip when starts it up (Lithium battery)?

A: For lithium battery like BYD , normally the switch trips for flowing reason:

1. BMS communication fails, or battery SOC is so low to protect itself.
2. Battery SOC is too low, battery trips to protect itself.
3. An electrical short-cut happened on battery connection side.

Q: Which battery should I use for Hybrid inverter?

A: For Hybrid inverter, it could connect lithium or lead-acid batteries, with nominal voltage 48V, max charge voltage 60V Compatible lithium batteries for now: BYD B-Box 2.5/5.0/7.5/10 For lead-acid batteries: please contact us to confirm if it is suitable to use.

Q: How to set the battery charging and discharging current?

A: Inverter factory default battery charging current 10A and discharging current 20A. You can adjust it according to the specifications of the battery used.

About Austa Solar App operation and monitoring

Q: Why Cannot save settings on App

A: This could be caused by losing connection to AU-WiFi.

1. Make sure you connected AU-WiFi (make sure no other devices connected) or router (if connected AU-WiFi to router) and on APP home page shows connection well.
2. Make sure Hybrid inverter under waiting mode (on APP) before you change any settings on Austa Solar disconnect grid/load/battery, only leave PV connected and then restart till see work mode as "wait" on APP.

Q: On App, some columns show NA, like battery SOH, etc. why is that?

A: NA means App does not receive data from inverter or server, normally it is because communication problem, such as battery communication, and communication between inverter and the APP.

About meter and power limit function

Q: How to Act Output Power Limit function?

A: For Hybrid Inverter system, the function could be realized by:

1. Make sure Meter connection and communication well;
2. Turn on Export Power Limit function and Set the max output power to grid on APP.

NOTE: If Out-put Power Limit set as 0W, then there might still have deviation max 100W . exporting to grid.

Q: Why there is still power exporting to grid after I set power limit as 0W?

A: Export limit could theoretically to minimum 0W, but there will have a deviation of around 50-100W for Hybrid Inverter system.

Q: Can I use other brand Meter to take over Meter in Hybrid inverter system or change some settings on Meter?

A: Cannot, because there the communication protocol is inset between inverter and Meter, other brand Meter cannot communicate. Also any manual setting change could cause Meter communication failure.

5.1 Disclaimer

The hybrid inverters are transported, used and operated under environmental and electrical conditions. We have the right not providing after-sales services or assistance under following conditions:

- Inverter is damaged during transferring.
- Inverter is out of warranty year and extended warranty is not bought.
- Inverter is installed, refitted or operated in improper ways without authority from us.
- Inverter is installed or used under improper environment or technical condition mentioned in this user manual, without authority from us.
- Installation or configuration of the inverter does not follow requirements mentioned in this user manual.
- The inverter is installed or operated against the requirements or warnings that are mentioned in this user manual.
- Inverter is broken or damaged by any force majeure like lightning, earthquake, fire hazard, storm and volcanic eruption etc.
- Inverter is disassembled, changed or updated on software or hardware without authority from us.
- Inverter is installed, used or operated against any related items in international or local policies or regulations.
- Any non-compatible batteries, solar panels, loads or other devices connected to Hybrid inverter system.



We will keep right to explain all the contents in this user manual.

• Maintenance

The inverter requires periodically maintenance, details as below:

Heat sink: please use clean towel to clean up heat sink once a year.

Torque: please use torque wrench to tighten AC and battery wiring connection once a year.

DC switch: check DC switch regularly, active the DC switch 10 times in a row once a year. Operating DC switch will clean contacts and extend lifespan of DC switch.



Make sure inverter is totally isolated from all DC and AC power for at least 5 mins before maintenance.

Appendix: Protection category definition

Overvoltage Category Definition

Category I	Applies to equipment connected to a circuit where measures have been taken to reduce transient overvoltage to a low level.
Category II	Applies to equipment not permanently connected to the installation. Examples are appliances, portables tools and other plug-connected equipment.
Category III	Applies to a fixed equipment downstream of and including the main distribution board. Examples are switchgear and other equipment in an industrial installation.
Category VI	Applies to equipment permanently connected at the origin of an installation (upstream of the main distribution board), Example are electricity meters, primary over-current protection equipment and other equipment connected directly to outdoor open lines.

Moisture Location Category Definition

Moisture Parameters	Level		
	3K3	4K2	4K4H
Temperature Range	0~+40 °C	-33~+40 °C	-20~+55 °C
Humidity Range	5%~85%	15%~100%	4%~100%

Environment Category Definition

Environment Condition	Ambient Temperature	Relative Humidity	Applied to
Outdoor	-20~+50 C	4%~100%	PD3
Indoor Unconditioned	-20~+50 C	5%~95%	PD3
Indoor Conditioned	0~+40 C	5%~85%	PD2

Pollution Degree Definition

Pollution Degree I	No pollution or only dry, non-conductive pollution occurs. The pollution has no influence.
Pollution Degree II	Normally only non-conductive pollution occurs. Occasionally, however, a temporary conductivity caused by condensation must be expected.
Pollution Degree III	Conductive pollution occurs, or dry, non-conductive pollution occurs, which becomes conductive due to condensation which is expected.
Pollution Degree IV	Persistent conductive pollution occurs, for example, the pollution caused by conductive dust, rain and snow.

5.2 Technical Parameters

Model	AU3KESL	AU3.6KESL	AU4KESL	AU4.6KESL	AU5KESL	AU6KESL	AU8KESL
PV Input							
Max. DC input power(W)	4500	5400	6000	6900	7500	9000	12000
Max. DC input voltage(V)	500						
MPPT voltage range(V)	150-450						
Starting voltage(V)	125						
Max. input current(A)	18	18/18	18/18	18/18	18/18	18/18	30/18
Max. short circuit current (A)	22.5	22.5/22.5	22.5/22.5	22.5/22.5	22.5/22.5	22.5/22.5	37.5/22.5
Number of MPP trackers	1	2	2	2	2	2	2
Strings per MPP tracker	1						2/1
AC Output (Grid)							
Rated output power (W)	3000	3600	4000	4600	5000	6000	8000
Max. output apparent power(VA)	3300	3960	4400	5060	5500	6600	8800
Rated output voltage(V)	220/230/240						
Rated output frequency(Hz)	50/60						
Max. output current(A)	15	18	20	22	25	27	40
THDi	<3%						
Output power factor	~1 (-0.8 leading~+0.8 lagging)						
AC Output (Two Backup)							
Full Max. output power(W)	3000	3600	4000	4600	5000	6000	8000
Max. output apparent power(VA,sec)	6000,15	7200,15	8000,15	9200,15	10000,15	10000,15	16000,15
Rated output voltage(V)	220/230						
Rated output frequency(Hz)	50/60(±0.2%)						
Back up1 Max. output power(W)	3000	3600	4000	4600	5000	6000	8000
Back up2 Max. output power(W)	3000	3600	4000	4600	5000	6000	8000
Output Power Factor(off grid)	1~(0.8 leading to 0.8 lagging)						
Output Current Harmonic Distortion	THD<3%(Nonlinear load); THD<1.5%(Linear load)						
Max. output current(A)	14	16	18	21	23	27	40

Battery Parameters							
Battery Type	Lithium or lead acid battery						
Rated battery voltage(V)	48						
Voltage range(V)	44-57						
Max. charge/discharge current(A)	75	90	100	110	120	120	190
BMS communication	CAN/RS485						
Efficiency							
Max. efficiency(PV)	97.6%						
Max. efficiency(cell)	94.5%						
European efficiency	97%						
Protection							
PV input reverse polarity protection	Yes						
PV insulation resistance detection	Yes						
Residual current detection	Yes						
Output over current protection	Yes						
Output short circuit protection	Yes						
Output over voltage protection	Yes						
Others							
Operating temperature range(°C)	-25~60						
Storage temperature range(°C)	-30~65						
Humidity range	0~95%						
Operating altitude (m)	≤4000						
Communication	RS485/CAN/WiFi/Ethernet/4G						
Protection degree	IP66						
Noise (db)	<25						
Size (W×H×D mm)	424*555*197			427*554*198			
Weight (kg)	19			19			
Standard							
EN 62109-1/2,IEC 62109-1/2,EMC 61000,EN50549,VDE 4105/0124,NRS 097-2-1,IEC61727/62116/61683							

Tel: +86 574 89137130 | Email: marketing@osdasol.com | Add: 1-1 NO.136 Haichuan Road Jiangbei District Ningbo Zhejiang P.R. China

Search "Austa Solar"
on Google Play and App Store

