

AU Series

Grid-tied PV Inverter user manual



AU 18~30K3P-LV

The logo for Austa, featuring the word 'Austa' in a bold, sans-serif font. A yellow swoosh underline is positioned beneath the letters 'a', 's', and 't'.

NINGBO AUSTA SOLAR TECH CO.,LTD.

Contents

Thank you for choosing AUSTA on-grid PV inverter. In order to ensure your safety and proper use, please read the manual in details before using. Thanks for your cooperation!

1. Overview	1
1.1 Use of this manual	1
1.2 Symbols	1
2. Description	2
2.1. Brief Introductions	2
2.2 General introduction	3
2.3 Inverter dimension	4
3. Installation	5
3.1 Installation Procedure	5
3.2 Installation Preparation	6
3.3 Installation environment requirements	7
3.4 Mechanical Installation	10
3.5 Electrical Connection	12
4. Monitoring	22
4.1 Overview	22
4.2 AUSTA PV Wizard App -SolarInfo	24
5. Trial run	25
5.1 Inspection before trial run	25
5.2 Trial run steps	25
5.3 Shut down	26
6. Shut down & Dismantle	27
6.1 Stop the inverter	27
6.2 Dismantle the inverter	27
6.3 Discarding the inverter	27
7. Operating	28
7.1 Working Mode	28
7.2 Startup mode	30
7.3 Power generation process	33
7.4 Disconnect from the grid	33
8. Maintenance	34
8.1 Maintenance	34
8.2 Troubleshooting	34
9. Specification	37
9.1 Specification	37
9.2 Quality guarantee	38

1

Overview

1.1 Use of this manual

This manual mainly introduces installation, operating and maintenance of inverter and related technical parameters. It is suitable for people who install the inverters and do other related jobs. Readers need to have some knowledge of electric, electrical wiring and mechanics. Before installing this product, please read this manual carefully, and put it in a suitable place, so as to ensure that relevant personnel of installation and operation can easily get it.

AU18/20/25/30K3P-LV series

1.2 Symbols

Please strictly follow below safety rules when installing and operating.



DANGEROUS

DANGEROUS indicates a hazard with a high level of risk which, if not avoided, will result in death or serious injury.



WARNING

WARNING indicates a hazard with a medium level of risk which, if not avoided, could result in death or serious injury.



CAUTION

CAUTION indicates a hazard with a low level of risk which, if not avoided, could result in minor or moderate injury.



NOTE

NOTE indicates a situation which, if not avoided, could result in equipment or property damage.

2.1. Brief Introductions

On-grid PV power generation system usually is composed of solar panels, junction box, inverter, ammeter and power grid. The core of the system is PV grid-connected inverter. The sunshine irradiates on the surface of the solar panels, solar panels output DC, converted by inverter, then output AC of the same frequency and phase with the grid, and then feed into the grid.

The grid-connected PV inverter is a three-phase series transformerless inverter, and its application in PV power generation system is shown in Figure 2-1.

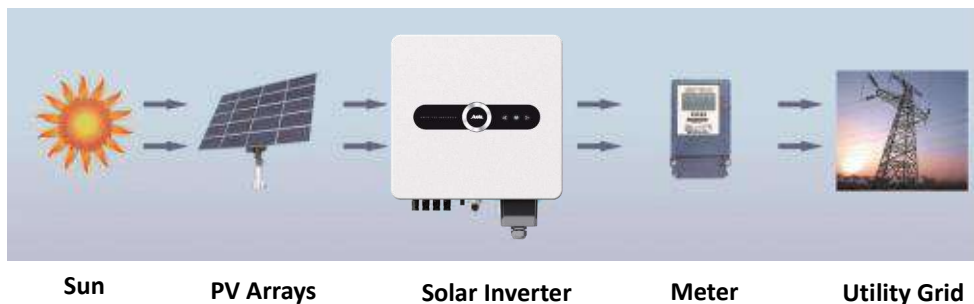

Fig 2-1 Grid-connected PV Power Generation System

PV arrays: monocrystalline silicon, polysilicon. The inverter can only be connected with solar panel with II level protection.

If the PV system exceeds the capacity of a single inverter, multiple inverters can be used in the system. Appropriate PV inputs are connected to each inverter on the input side, and connected to the power grid in parallel on the output side.



WARNING

The inverter cannot be connected to PV arrays that require positive or negative grounding.

Do not connect the local load between the inverter and the AC circuit breaker.

The inverter is only applicable to the grid-connected power generation system, except for the above occasions, the inverter is not used in other occasions.

Product performance:

- Transformerless, highest efficiency is 98.7%.
- Wide input voltage, MPPT efficiency is 99.9%.
- Active and passive anti-islanding protection technology.
- Comprehensive protection, higher reliability.
- IP66 Outdoor design, suitable for harsh environment .
- RS485 communication.
- Optional GPRS/WIFI communication function.

2.2 General introduction

✧ Appearance and interface



Fig 2-2 Appearance

Figure 2-2 shows the product appearance. The picture is for reference only. The external interface is located at the bottom of the product, including PV+ input port, PV - input port, WIFI/GPRS/RS485 communication port, AC output port, and DC switch (side).

Figure 2-3 shows the schematic diagram of the external interface. (Take AU 18 K3P-LV as an example).

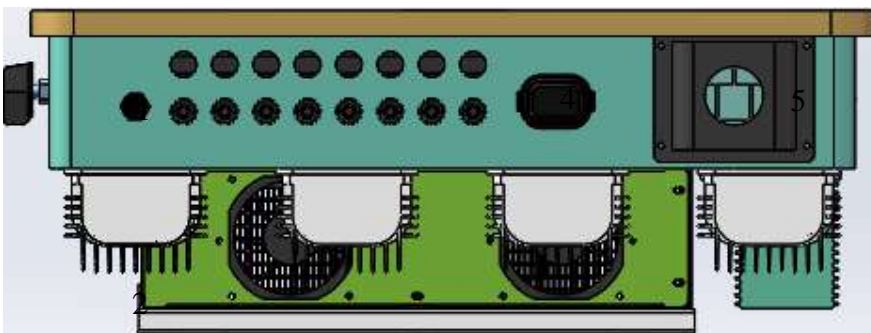

Fig 2-3 External Port

Table 2-1 External interface

No.	Name	Description
1	PV input port +	Inverter's DC input port, connect with + port of PV arrays
2	PV input port -	Inverter's DC input port, connect with - port of PV arrays
3	DC switch	Electric cut off between inverter and PV arrays
4	WIFI/GPRS/RS485	Connect inverter with PC through this port for remote monitoring
5	Earthing bolt	Connect machine case with ground
6	AC output port	Connect with phase L1, L2, L3 and wire N of the grid through the breaker, connect ground wire to the ground

2.3 Inverter dimension

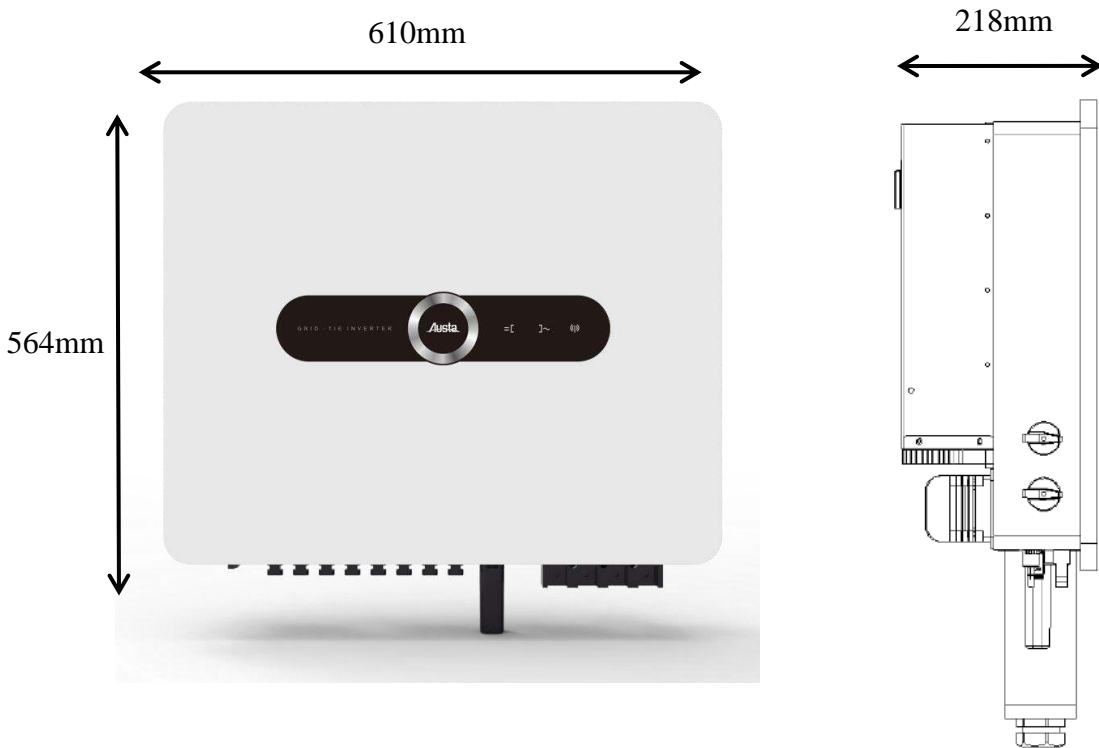

Fig2-4 Inverter dimension (Unit: mm)

3

Installation

The following are the installation instructions for this product. Please read these instructions carefully to help you install it correctly.

3.1 Installation Procedure

Before installing and operating this product, please strictly abide by the installation sequence and warning symbols.

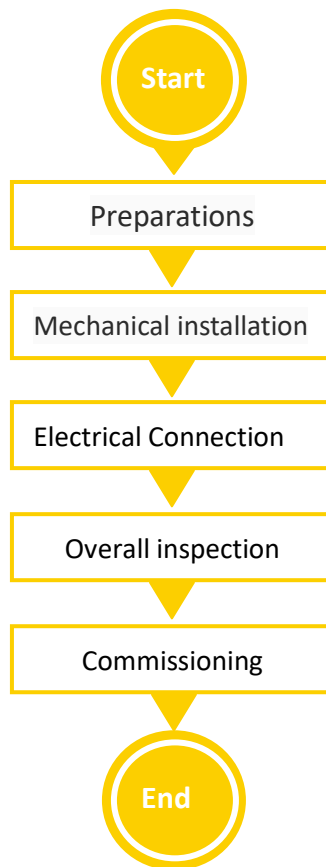

Fig 3-1 Installation procedure

3.2 Installation Preparation

✧ Check whether there is damage during transport

Although we have carefully tested and inspected the inverter before shipping, there might be damage during transport. So please check them before installation. If there is any damage, please contact the shipping company or directly contact us. Please provide photos of the damaged part. We will provide the best service as fast as possible.

- Check the packing case for damage when receiving the goods.
- Check whether the goods are complete and consistent with the order according to the packing list.
- After unpacking, check whether the internal devices are intact.



Note

Do not discard the original packaging of the inverter so that it can be returned to the original packaging box for storage when the inverter is out of service!

Tab 3-2 Scope of supply

No	Item	Qty		Description
A	Inverter	1		-----
B	fixed plate	1		For fixing inverter to mounting surface (solid wall, etc.)
C	document	1		Including:Instruction manual, certificate of quality, packing list, product test report, etc
D	Mounting plate fixing screws	4		Screw M8X30, hex nut M8, flat washer 8
E	fixed screw	2		M6x12, for fixing the inverter with the fixing plate
F	DC connector	18-30K	8	It is used to connect the PV arrays to the inverter. Ensure that the polarity of the PV arrays is consistent with that of the inverter input terminal.

✧ Inverter storage

If the inverter is not put into operation immediately, please store the inverter in a specific environment:

- The inverter must be packed in the original packing case, sealed with adhesive tape, and placed in a clean and dry environment to prevent dust and water vapor erosion.
- The temperature of the storage site should be between -25°C and 60°C, and the relative humidity should be between 0 and 100%.
- If the storage space really needs to be stacked with more than one stack, the stack must be aligned one by one, and the maximum stacking layer does not exceed.
- Long-term storage is not declared during stacking. Do not tilt or invert the packing case.
- After long-term storage, the inverter can be put into operation only after comprehensive inspection

and testing by professionals.

3.3 Installation environment requirements

The selection of the inverter installation environment plays an important role in its safe operation, performance guarantee, and life guarantee. Here are some basic requirements:

- The inverter protection level reaches IP65 and can be used for indoor or outdoor installation.
- In order to extend the service life of the inverter and protect the inverter from direct sunlight, rain and snow, choose a sheltered installation location as much as possible.



- The installation site (wall or steel frame) of the inverter should be solid and reliable, it should be able to withstand the weight of multiple inverters for a long time, and it should have fire resistance.

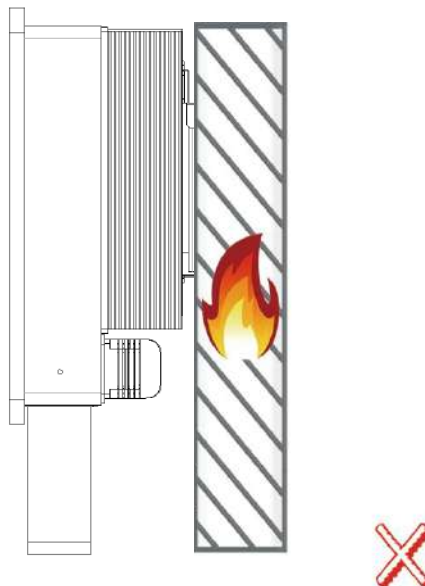

- The inverter should be installed in a location where electrical connections, operation and maintenance are easy.
- The installation height is preferably such that the LCD screen is at eye level for easy operation of the LCD display panel.

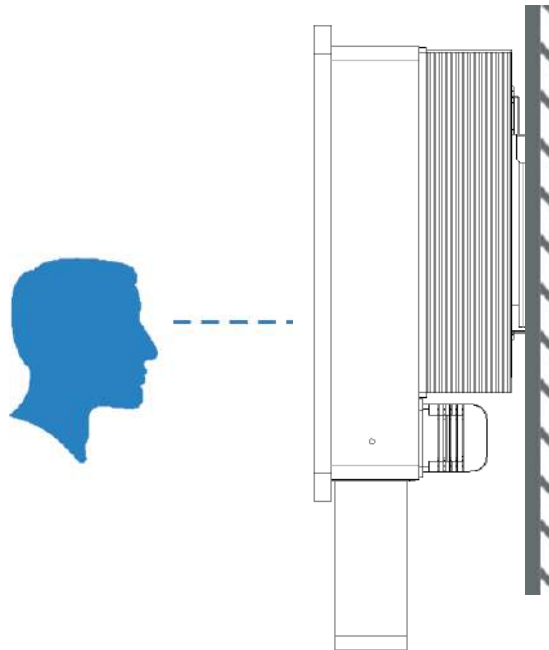

- The installation space requires good ventilation. Do not install the inverter in a closed space, and do not allow flammable materials or flammable gases.

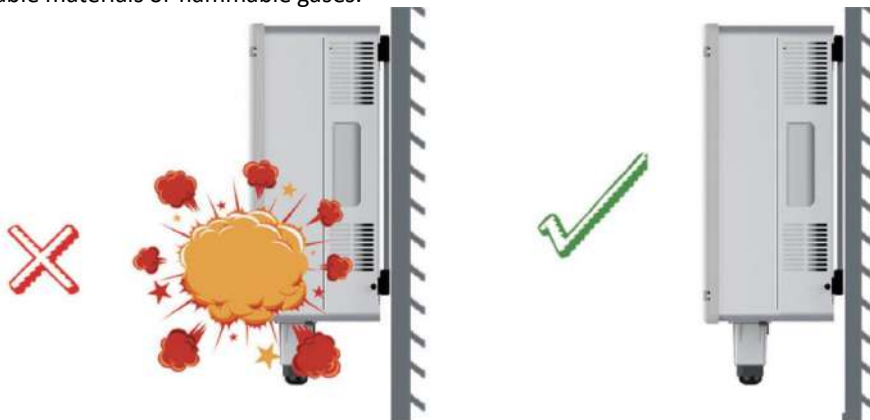

- The temperature range of the installation environment should be between -25°C and 60°C , and the relative humidity is $0\sim 100\%$ (when the ambient temperature exceeds 45°C , the output power of the inverter will be reduced).



Minimum ambient temperature: -25°C



Maximum ambient temperature: 60°C



Environment humidity: 0~100% No condensation

- The installation environment requires cleanliness.
- The inverter needs to be installed uprightly, and cannot be placed horizontally or upside down, or tilted.

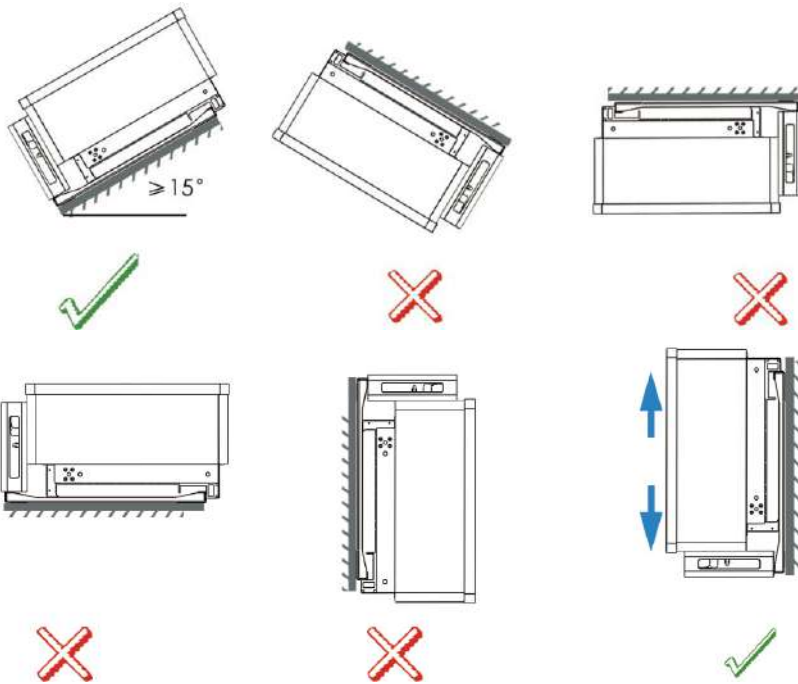

If multiple inverters are installed horizontally side by side, it is best to keep the distance between them at least 50cm, and no objects should be placed on the top of the inverter. There should also be enough space in the front and back to facilitate system heat dissipation; it is recommended to stagger the inverters.

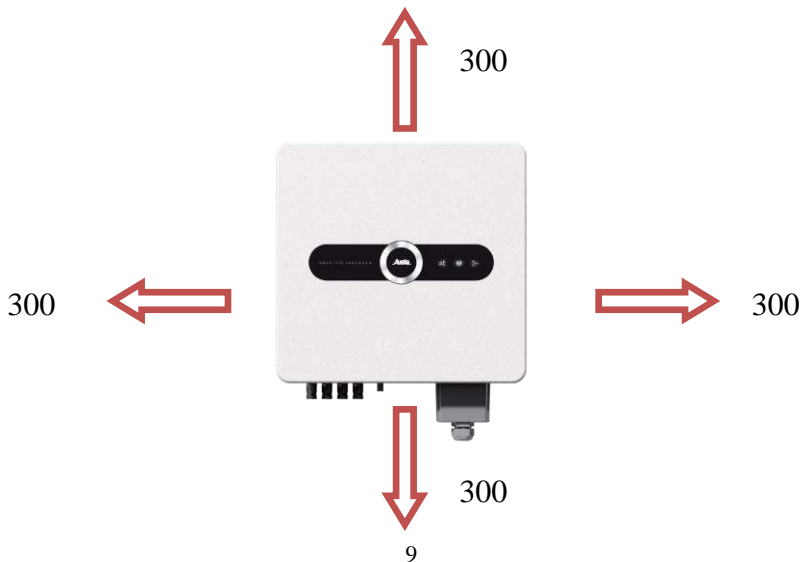

- Do not install the inverter in a place where children can touch it. During the operation of the inverter, the local temperature (such as the radiator) is high, so as to avoid burns or electric shock.



DANGEROUS

Do not place the inverter with inflammable and explosive objects.



CAUTION

During the operation of the inverter, the temperature is high, please do not touch it!

- Do not install the inverter in the living area to avoid noise affecting daily life.

3.4 Mechanical Installation

3.4.1 Setting tool

- ◇ Wrench
- ◇ Impact electric drill
- ◇ Phillips screwdriver
- ◇ Hexagon socket wrench
- ◇ Megohmmeter and multimeter

3.4.2 Move inverter

Before installation, take the inverter out of the packing box and transport it to the selected installation site. To move the inverter, follow the following instructions:

- ◇ The weight of the machine is about 39kg.
- ◇ Move the inverter according to the requirements in the quick installation instructions.
- ◇ At least two workers work together to move the inverter or with other appropriate moving tools.
- ◇ Prevent the inverter from knocking or falling.

3.4.3 Install inverter

The fixing plate and fastener expansion bolts in the accessory bag are used to vertically install the inverter on the wall or metal support.

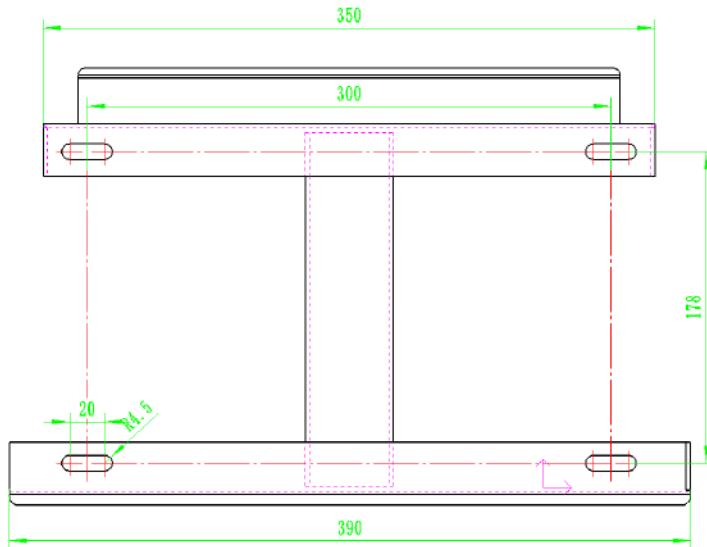

Fig 3-3 Drawing of fixed plate dimensions

- If the chassis is to be installed on a concrete wall, drill holes on the wall based on the specifications of the fixing plate, secure the fixing plate to the wall using expansion bolts, and hang the chassis on the fixing plate.

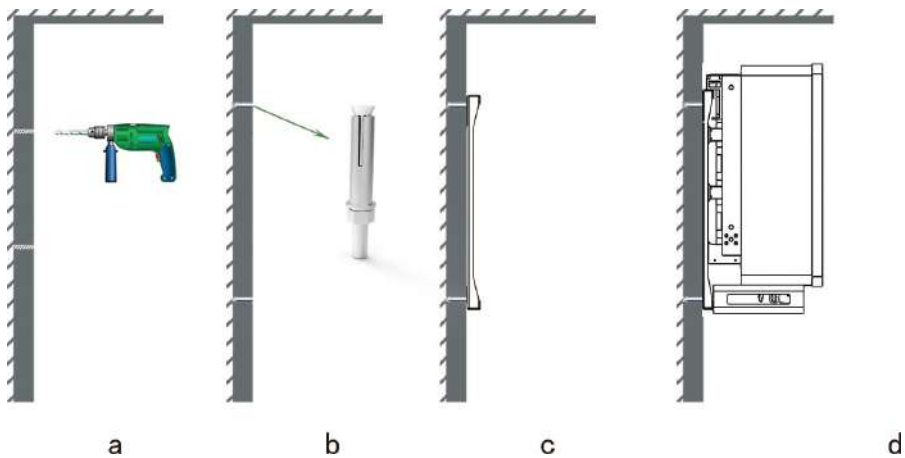
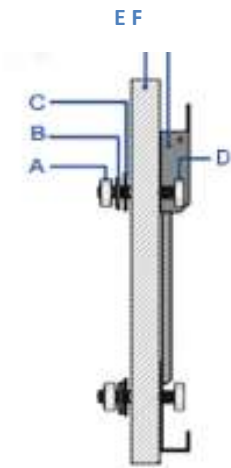

Fig 3-5

- If it is installed on a metal bracket, drill holes on the metal bracket according to the specifications of the fixing plate, fix the fixing plate with M10 bolts, and hang the chassis on the fixing plate.

No.	Name	Description
A	Hexagon nuts	M8
B	Spring gasket	Φ8
C	flat gasket	Φ8

Mounted panel



D	Full thread bolt	M8
E	Metal support	
F	fixing plate	Accessory

Fig 3-6

- After hanging the inverter on the fixing plate, use screws to fix the inverter on the fixing plate.

Note: In the process of installing the inverter, please pay attention to keep the balance, so as not to hit the wall or other obstacles and damage the machine shell.

3.5 Electrical Connection

3.5.1 Safety instructions

As an electronic device, touching any live part can be fatal. Inverter installation must be completed by professional electrical and mechanical engineers.



WARNING

The inverter must be installed by qualified professionals. Improper wiring may result in operator injury or permanent damage equipment.

Before making electrical connections, remember that the inverter has a dual power supply. Electrical personnel must be equipped with protective equipment, such as helmets, insulating shoes, protective gloves, etc.

Matters needing attention:

- ◇ When installing, in addition to wiring terminals, please do not move the rest of the inside of the box.
- ◇ All electrical installations must comply with local regulations and electrical codes;
- ◇ If you need to maintain the device, contact the equipment supplier.
- ◇ Permission of local power supply department shall be obtained when the equipment is connected to the grid for power generation.



WARNING

Ensure that the input Dc voltage does not exceed 1000V. Higher input voltage may permanently damage the equipment and cause other losses. In this case, the company does not undertake warranty and liability.

3.5.2 Wiring requirements

After the inverter is firmly installed to the installation site, it can be connected to the PV system. Electrical connections must comply with local laws and regulations. The following are the wiring requirements of the inverter.

- ◇ PV arrays

The open circuit voltage of the photovoltaic array should not exceed 1000V.



NOTE

Maximum open-circuit voltage of PV arrays: 900 V.

Maximum power of PV arrays: see 7.1 Technical Specifications.

- ◇ Three-phase power grid

The inverter will constantly check whether the grid meets the grid-connection conditions. The following are the grid limits that meet the grid-connection conditions. At the same time, permission should be obtained from the local power department before installing grid-connected PV inverters.



NOTE

Grid phase voltage: 170VAC-265VAC, grid frequency: 47.5-52.5 Hz /57.5-62.5Hz.

- Cable:

AC and DC connections should comply with local safety regulations, and the wire diameter should ensure the most basic overcurrent capability.

Table 3-4 Cable specification recommendations

Part	connection	Cable size	Torque
DC terminal	PV array	4~6mm ²	NA
Ground terminal	AC cable	6~10mm ²	10~12N.m
Grid terminal	Power grid	16~35mm ²	10~20N.m
RS485 terminal	Communication cable	0.3~4mm ²	0.6N.m

COM terminal	Data collector	NA	NA
DC surge protection device	NA	NA	NA

- Breaker:

In order to ensure the safe installation and operation of the equipment, it is necessary to configure a manual circuit breaker. The circuit breaker should comply with the local safety regulations and standards, and meet the basic overcurrent and overvoltage protection capabilities. Among them, the voltage range of the AC circuit breaker should be greater than **450V**, and the current range should be **80-100A** (optional according to the model).



NOTE

Multiple inverters cannot share one circuit breaker.

Load cannot be connected between the inverter and the circuit breaker.

- Leakage protector:

The inverter is equipped with an integrated comprehensive leakage current monitoring unit, and the inverter can distinguish between fault current and capacitor leakage current. When the inverter detects a leakage current greater than the allowed value, it will quickly disconnect from the grid.

3.5.3 Inverter wiring

- Leakage protector:

The AC terminal is in the lower half chamber of the inverter, and the AC connection mode is three-phase five-wire grid connection to L1, L2, L3, N (the N wire can not be connected), PE.



NOTE

If the PID lifting function is added to the AC side, then:

The neutral point of the power grid on the inverter side cannot be grounded.

The Ac cable must be 1000V or 600V ;

Solution "3+1" is the best choice for ac PDC SPD test. "3" requires that the U_c is not less than 385Vac. "1" requires dc breakdown voltage $U_{ag} > 600V_{dc}$;

If there is no PID lifting requirement on the AC side and no other special requirements:

The neutral point of the power grid is grounded or the ac output terminal N inside the machine is connected to the terminal PE .

Wiring steps:

1) Disconnect the AC circuit breaker, ensure that the AC cable connected to the terminal is not live, and use a multimeter to measure and confirm.

2) Follow the instructions below to strip the cables as shown in the picture below.

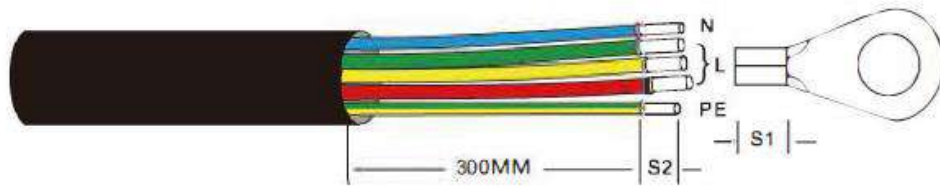

Fig 3-7 AC stripping

NOTE: S2 (insulation stripping length) is 2mm-3mm longer than S1 (OT cable terminal crimping area).

3) Remove the insulation layer of the cable through the cable crimping area of the OT terminal, and then crimp the terminal using a hydraulic crimping tool. The crimped portion of the terminal must be insulated with heat shrink or insulating tape.

Note: If you choose aluminum cables, you need to use copper-aluminum transfer terminals to avoid direct contact between copper bars and aluminum cables (copper-aluminum transfer connectors are configured according to the selected cables).

4) Remove the 4 screws on the inverter junction box, then remove the junction box cover and pass the cables through the nut, sheath and AC terminal cover. Use a socket wrench to connect the cables to the AC junction box in turn. Tighten the screws on the junction box. Torque is 10~20N.m.

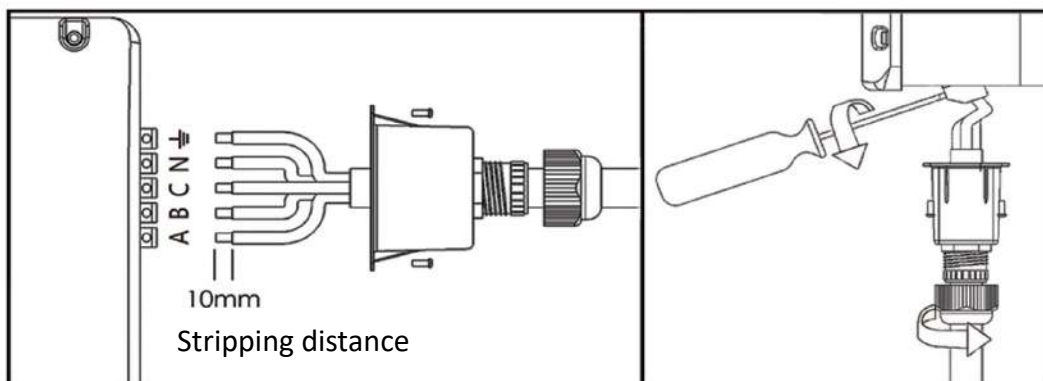

WARNING

- Do not connect the phase lines L1, L2, and L3 and line N on the AC side to anchors.
- Ensure that cables are securely connected to prevent cable insulation from being squeezed or stressed. Improper connection may damage the inverter.



NOTE

- Except for the AC side terminals, the terminals on other sides of the inverter are plug-in type.
- It is best to use flexible cables for AC side cables.

Tighten the tightening nut of the AC cable gland at the bottom of the box.

- DC cable
- ◆ PV input configuration

The inverter has ten PV arrays input regions DC1~DC4. The inverter is configured with an MPPT tracker for each input region.



Dangerous

High voltage! Electrical shock!

Pay attention to safety before electrical connection. Exposure of PV arrays to sunlight will generate dangerous voltage.



WARNING

Before connecting the PV arrays to the inverter, ensure that the PV arrays is well insulated to the ground.



NOTE

The following precautions must be met, otherwise the damage caused by the inverter will not be covered by the warranty.

When designing a PV array, make sure that the voltage of each PV string cannot exceed 1000V even at the lowest temperature. Otherwise, the inverter will be irreversibly damaged.

Ensure that the maximum short-circuit current on the DC side is within the allowable range of the inverter; otherwise, the inverter may be irretrievably damaged.

The 2 photovoltaic inputs operate independently and each has an independent MPPT. Therefore, the two photovoltaic inputs can be different from each other, including: different panel types; different numbers of cells; different inclination angles and different azimuth angles.

- DC cable standards

Type	Cross-sectional area(mm ²)		Cable outer diameter
	Range	Recommend	
PV1-F	4~6	4	5.5~9mm
	12AWG~10AWG	12AWG	

Table 3-5 DC Cable Requirements

DC cable connection steps



DANGEROUS

High voltage! Electrical shock!

There may be high voltage in the inverter!

Before electrical operation, make sure that all cables are not live.

Before the electrical connection of the inverter is completed, the AC circuit breaker switch shall not be installed.

1. Remove 7mm of insulation layer from all DC cables.

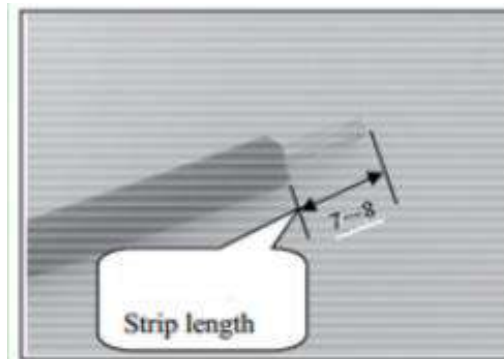

2. Use crimping pliers to bundle cable ends at wiring terminals.

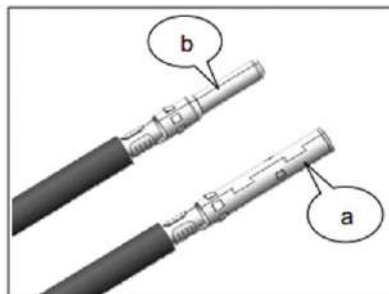

a. female terminal b. male terminal

3. Route the cable through the cable sealing sleeve.
4. Insert the wiring terminal into the insulation sleeve until it is fastened. Gently pull the cable to ensure that it is firmly connected.
- 5 Tighten the sealing sleeve and insulation sleeve with 2.5 to 3N.m force.

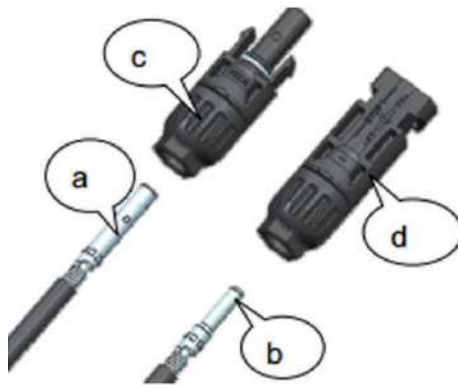

- a. Male terminal
- b. Female terminal
- c. Male housing body
- d. Female housing body

6. Verify that the polarity of the PV arrays cables is correct.



NOTE

If the DC input polarity is reversed, the inverter will not work properly.

7. Off DC switch.

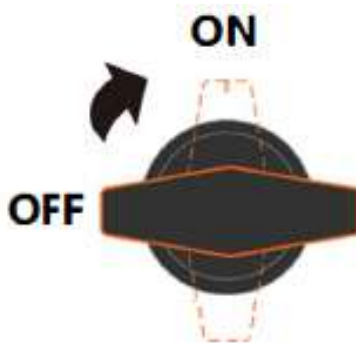

8. Check whether the polarity of the connecting cables of the PV string is correct, and ensure that the open circuit voltage does not exceed the upper limit of the inverter input, 1000V, even at the lowest operating temperature.





NOTE

- Before connecting the DC terminal to the inverter, check the positive and negative polarity of the PV arrays and insert the terminal into the input terminal at the bottom of the inverter.
- In the same MPPT, it is not allowed to reverse a single PV array. Otherwise, the system or inverter will fail permanently.

7. Insert the positive and negative connectors into the input terminals at the bottom of the inverter and buckle them tightly.

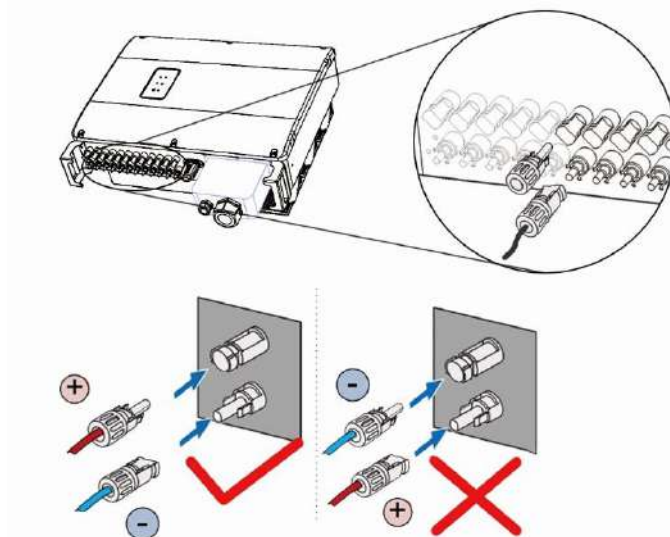

8. Repeat the preceding steps to connect other PV arrays.
9. Seal the vacant DC terminal with a terminal cover.

- Grounding



WARNING

Since the inverter is a transformerless type, it is required that the positive and negative poles of the PV array cannot be grounded, otherwise the inverter will not operate normally.

◆ Grounding system

In this PV power generation system, all non-current-carrying metal parts and equipment housings should be grounded (such as the bracket of the PV arrays, the inverter housing, etc.).

A single inverter system needs to ground the "PE" cable.

Multiple inverter systems support multi-point grounding, but all inverter "PE" cables and the grounding points of the metal frame of the PV arrays need to be connected to the equipotential line (depending on

site conditions) to achieve equipotential connection .

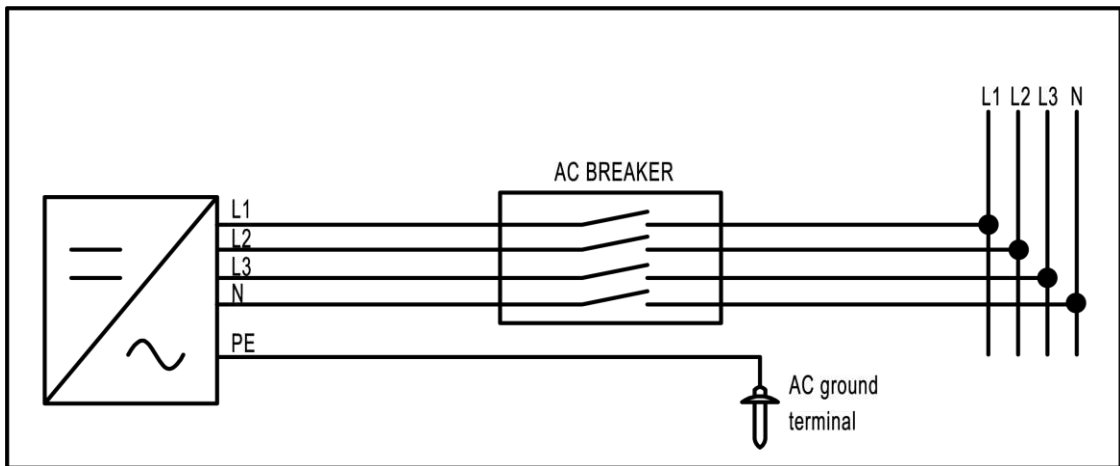
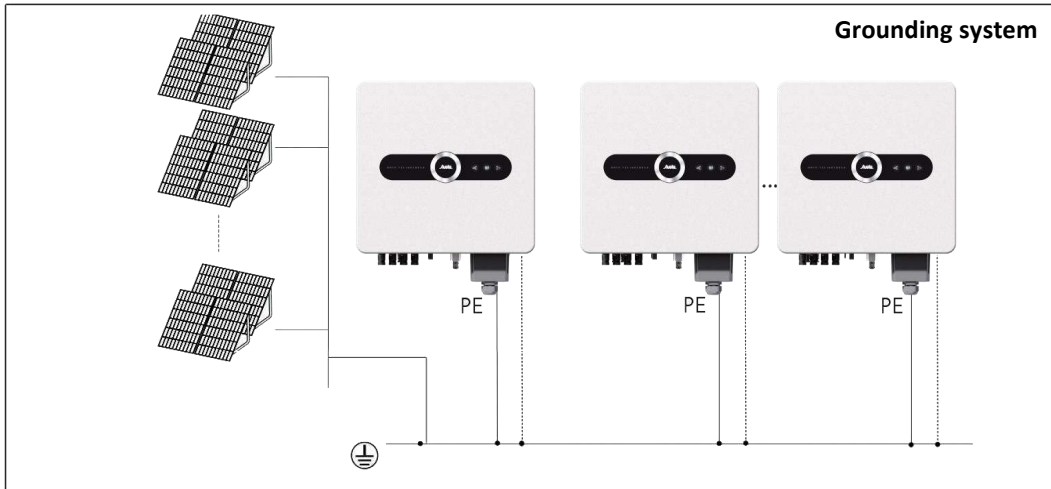

Grounding diagram

◆ Secondary protection grounding

There is a secondary protection grounding terminal at the bottom of the inverter, which must be grounded.



WARNING

- The grounding connection of the secondary protection grounding terminal cannot replace that of the PE terminal in the AC cable. Ensure that both terminals are reliably grounded. Otherwise, manufacturers and suppliers does not assume any responsibility for possible consequences.
- Since the inverter is transformerless, it is required that the positive and negative poles of the PV arrays cannot be grounded, otherwise the inverter cannot work normally.

◆ Cable grounding

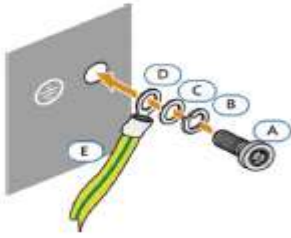

Secondary protection grounding connection.

Connecting parts are not (included in the delivery).

No.	Item	Description
A	Screw	M6×12
B	Locking gasket	
C	gasket	
D	cord end terminal	
E	green and yellow ground wire	

The cross-sectional area of the yellow-green line must be the same as that of the PE cable in the AC cable.

4

Monitoring

4.1 Overview

The inverter has a variety of communication methods. When users need to monitor the operation information of the photovoltaic power generation system, we provide the communication system solutions shown in Figures 4-1 and 4-2.

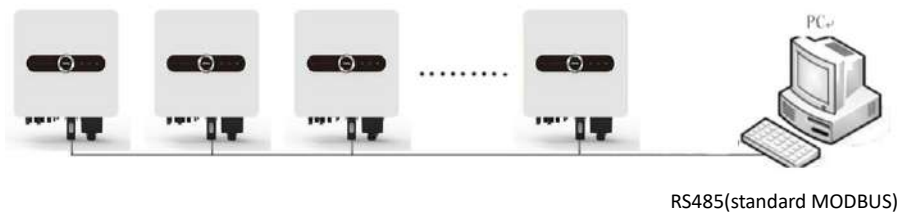

Figure 5-1 RS485 (standard MODBUS protocol) communication system mode

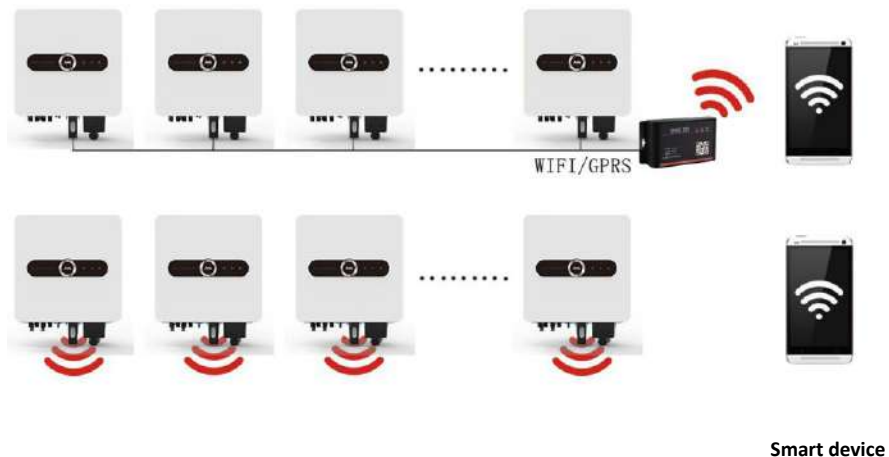
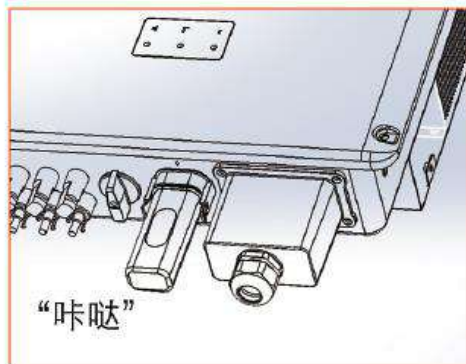
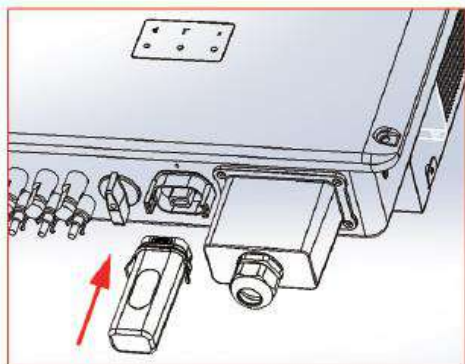

Figure 4-2 WIFI/GPRS communication system mode

After installing the GPRS or Wi-Fi data collector module, you can monitor the operation of the PV system through the AUSTA App program “Ausat Solar”.

• Collector description



4.2 AUSTA PV Wizard App -SolarInfo

Austa Web/Austa Solar APP is rich in functions, covering the entire life cycle of the power station, it perfectly meets the needs of one-stop management. Austa provides installers, operation and maintenance providers, and investors with various tools covering the development period, construction period, and operation and maintenance period of the power station. At the same time, it also provides practical functions such as equipment-based alarm management, protocol management, and control command management for major equipment manufacturers and their distributors.

- Website Login

Web: <http://partner.austasolar.net/>

- Software Installation

Method 1: For ios vesion, earch for "Austa Solar" in the App

Store to download and install, and for the Android version, search for

"Austa Solar" in the "Google Market" to download and install.

Method 2: Scan the QR code of the icon, enter the download address page, and open the download with a browser.



android



ios

5

Trial run

5.1 Inspection before trial run

Trial run is an important step for PV system installation. Proper trial run can prevent fire and other accidents. Correctly connect the PV arrays, inverter and ac power grid according to the installation process described above, and check the content before starting the inverter.

✧ PV arrays

Before starting the inverter, check the PV arrays on site to check whether the open-circuit voltage of each solar panel meets the requirements.

- Accurately record all values measured in the field.
- Make sure positive and negative polarity is correct, otherwise the machine will be seriously damaged.
- Use a megohmmeter to test the color edge resistance of the positive and negative poles of each PV array to the large landlord $> 2M \Omega$.

✧ Communication and accessories

Check that the RS485 communication cables are properly connected and securely connected, and that the shielding layer is properly grounded.

✧ Network

- Check if you can connect to the outside (send data).
- Check if you can read data from an external connection (remote service).

✧ AC circuit breaker,

modeling is reasonable

✧ Operating environment

- Confirm that the inverter is firmly and reliably installed.
- The environment is in good wind condition.
- No external items or tools are left on top of the inverter .
- Cables are properly distributed and well protected from mechanical damage.
- Empty terminals are sealed.
- All safety marks and warning labels shall be firmly and clearly visible on the inverter.

5.2 Trial run steps

If all the above inspections have passed, the inverter can perform the following trial operation steps for the first startup.

- ✧ Ensure that the above inspection items meet the requirements;

- ✧ Dc switch to ON position;
- ✧ Close the AC side circuit breaker;
- ✧ When the conditions required for normal operation of the machine are met, the inverter will automatically start and connect to the grid for power generation;
- ✧ Grid-connected PV inverter does not need manual control after normal operation, and has automatic shut down and start function after failure.

5.3 Shut down

- ✧ When the solar energy is insufficient to generate electricity, the grid-connected PV inverter shuts down automatically.
- ✧ Emergency shutdown process:

If an emergency shutdown is required, disconnect the CIRCUIT breaker and DC switch on the AC side in time. Otherwise, personal hazard may occur.



NOTE

Please strictly follow the above steps, otherwise the inverter will not work normally.

6 Shut down & Dismantle

6.1 Stop the inverter

It is not necessary to shut down the inverter manually under normal circumstances, but it is necessary to shut down the inverter for maintenance or operation. To disconnect the inverter from the AC/DC power supply, follow the following steps. Otherwise, personal injury may occur.

- ✧ Disconnect the external AC circuit breaker and prevent reconnection due to misoperation.
- ✧ Turn the DC switch to position “OFF”.
- ✧ Wait for about 10 minutes until the capacitor discharge is complete.
- ✧ Measure the AC voltage to the ground at the AC wiring terminal and ensure that the AC output voltage of the inverter at the AC circuit breaker is 0.
- ✧ Remove the AC cable.
- ✧ Remove the DC cable.



NOTE

Strictly follow the preceding steps; otherwise, the inverter may fail to work properly.

6.2 Dismantle the inverter

The user can dismantle the inverter according to the above electrical installation and mechanical installation and follow the reverse steps.

6.3 Discarding the inverter

For inverters that will no longer be put into operation in the future, users need to properly dispose of them by themselves.



NOTE

The control panel, batteries, modules and other components contained in the inverter may pollute the environment. Users need to properly dispose of them in accordance with relevant local laws and regulations.

7 Operating

7.1 Working Mode

The working modes of the inverter include-start mode, run mode, and standby mode. In each working mode, the LCD displays corresponding information.

7.1.1 Control panel with LCD display

The panel of the TLC series grid-connected PV inverter includes a LCD display. In order to better carry out the interactive operation of the man-machine interface, two LED indicator and a voice switch are set on the panel, as shown in Figure 7-1.

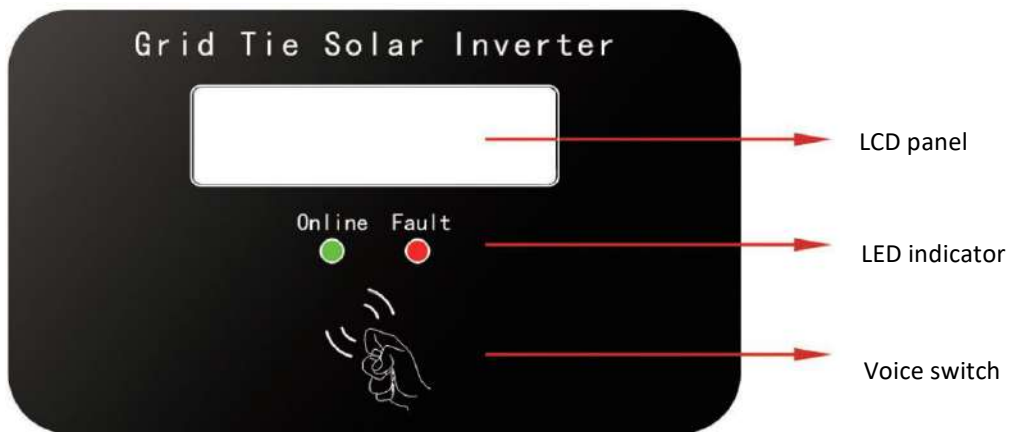



Fig 7-1 AU series LCD control panel

LED display status

No.	LED indicator	Description
1	Online	Grid-connected operation indicator (normal operation, grid-connected power generation indicator is on)
2	Fault	Fault indicator (lights on when a fault occurs)

Table 7-1 LED display status and meaning

The use of voice switch

Tap the picture icon  on the panel, the display interface of the LCD panel is switched

7.1.2 Control panel with indicator light

For the indicator panel of the TLC series grid-connected PV inverter, in order to better carry out the interactive operation of the man-machine interface, 3 LED lights are set on the panel, as shown in Figure 7-2.



Fig 7-2 AU series indicator panel

● LED display status

Function	Status		Description
Running	= [] ~	
			Grid-connected and power generation
			DC is normal, AC is not powered on
			DC is normal, grid-connected standby
			Equipment failure
			DC switch is not powered on
Communication	(())		
			The communication cable or communication module is connected, and there is data interaction on the communication channel
			The communication cable or communication module is not connected or there is no data interaction on the communication channel
Light ON		Light OFF	Light flashes

Table7-2 LED display status and display meaning



NOTE

The data in the following tables and graphs are only sample data, and take AU18K3P-LV as an example, the actual display content and data may change.

7.2 Startup mode

The start mode means that the light conditions meet the DC start conditions of the inverter, but the grid has not yet been connected to power generation. In this mode, the inverter information is displayed in sequence. After the display is completed, the inverter meets the grid-connected conditions and switches from the startup mode to the running mode, otherwise, it switches to the standby mode.

The screen display sequence of the startup mode is shown in Figure 7-3(take AU18K3P-LV as an example).

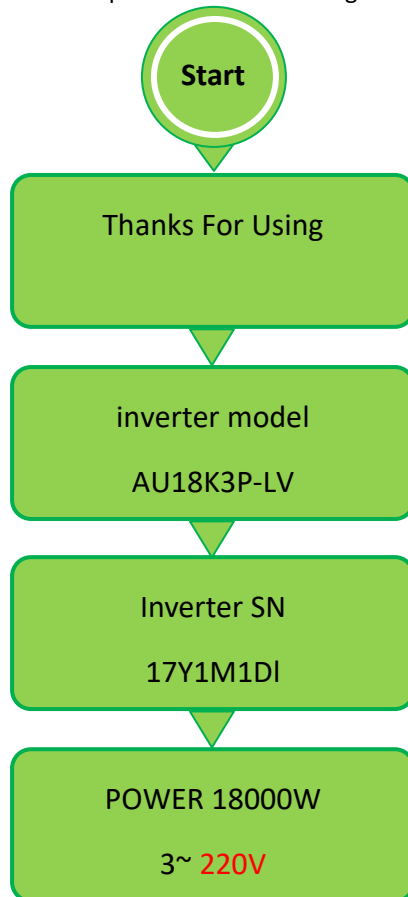

Fig 7-3 Start interface



NOTE

After the PV arrays voltage > 180V, the system will count down for 20 seconds. Within 20 seconds, the PV array voltage will always meet the grid-connected power generation requirements before it will switch to the operation mode.

● Running mode

In the Running mode, the inverter converts the DC power of the PV arrays into AC power and integrates it into the grid. At the same time, the inverter always outputs the maximum energy in the maximum power point tracking (MPPT) mode.

In running mode, the LCD refreshes the contents every two seconds, so the contents are only valid for the current two seconds. The LCD displays the default information. After 30 seconds, the LCD displays the default information, as shown in Figure 7-4.



Fig 7-4 Default interface of running mode

In running mode, the screen display content is shown in Table5-3 (take ASP-18KTLC-LV as an example)

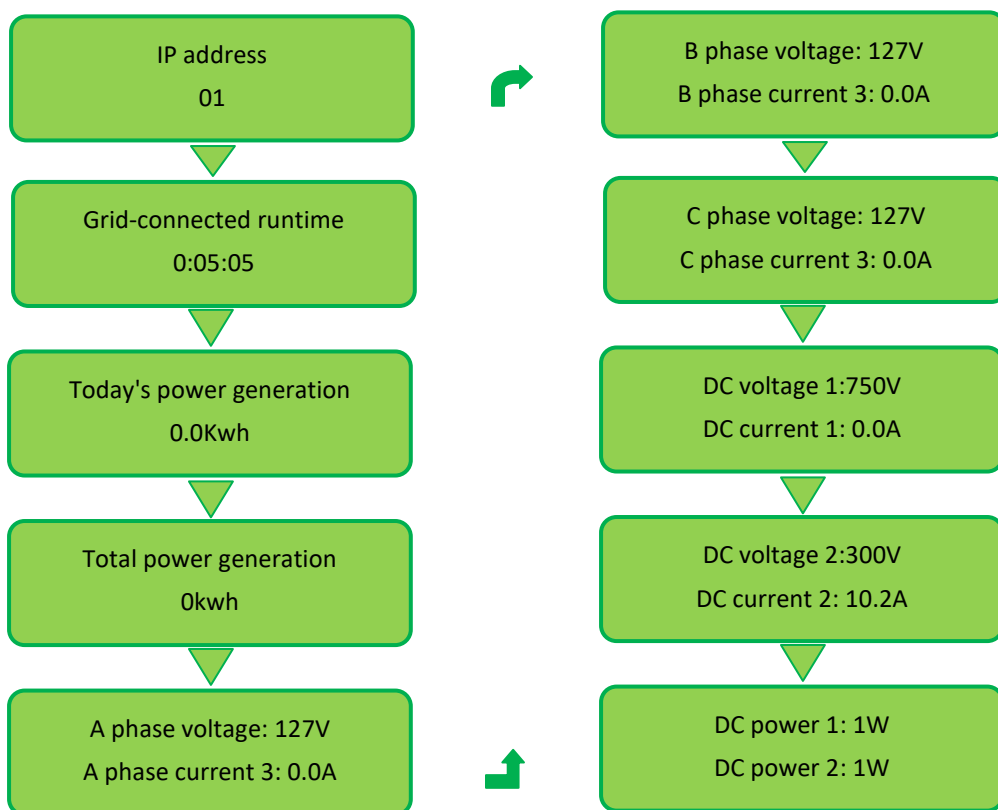

Fig 7-5 Normal interface of running mode

Note:

Tap the position of the voice-activated switch symbol, the LCD background light will be on, and the switching interface will be displayed at the same time. interface.



NOTE

The above various LCD display interfaces are switched by tapping the position of the voice-activated switch logo.



NOTE

If the DC side is powered off, it will be a new day for the inverter when it is powered on again, and the total energy generated on that day will be recalculated.

● Standby mode

The DC start and the grid connection condition is not met is the standby mode.

In the standby mode, the inverter continuously detects whether the grid-connected power generation conditions are met. After a 20-second countdown, the inverter switches from the standby mode to the running mode.

In standby mode, the second line of the default display interface of the inverter displays the standby information cyclically. The possible standby information is shown in 7-6, which is one or more of them. You can tap the front panel to switch to other display interfaces. check the detail information.



Fig 7-6 Standby mode cycles through the standby information page

Note:

Tap the position of the voice-activated switch logo, the LCD background display light will be on, and the switching interface will be displayed at the same time. If the LCD screen is no longer operated, after 20 seconds, the background light will be off, and the LCD screen will return to the default display interface.



NOTE

The above various LCD display interfaces are switched by tapping the position of the voice-activated switch logo.

7.3 Power generation process

The grid-connected power generation process of TLC(M) photovoltaic grid-connected inverters is automatic, and the grid-connected process is briefly described (take **AU 18K3P-LV** as an example)

1. Close the DC and AC circuit breakers, and the inverter will enter the startup mode;
2. When the DC input side voltage is higher than 180V, the AC side voltage is 170Vac-265Vac, and the grid frequency is normal, the countdown starts,
3. The DC side starts after a countdown of 20 seconds;
4. After the DC bus voltage is stable, the inverter side starts to work, and the grid is connected to generate electricity.

7.4 Disconnect from the grid

When the following abnormality occurs in the grid, the inverter will be disconnected from the grid immediately.

- ✧ The grid voltage is outside the normal range of 170V~265V;
- ✧ The frequency of the food grid is outside the normal range of 47.5-52.5Hz/57.5-62.5Hz;
- ✧ The PV array voltage is outside the normal operating range of the inverter;
- ✧ The ambient temperature is outside the normal operating range of the inverter.

8

Maintenance



DANGEROUS

Do not open the machine. Users trying to repair the machine by themselves may cause electric shock and fire hazard.

8.1 Maintenance

Due to the influence of ambient temperature, humidity, dust and vibration, the internal components of the inverter will age and wear, which will affect the service life of the inverter. Therefore, daily and regular maintenance of the inverter should be carried out to ensure its normal Operation and service life.

- ✧ Clean the dust and debris from the radiator frequently.
- ✧ When dust accumulates on the PV arrays, clean the PV arrays with water, and the cleaning should be carried out when the weather is cool.
- ✧ Check the system regularly to ensure that all wiring and supply conditions are error-free.
- ✧ Always read the information on the LCD display to understand the changes in the inverter's working status.



WARNING

Never use a pressure washer to clean the inverter, or other cleaning methods that may cause water to enter the machine.

8.2 Troubleshooting



WARNING

Only qualified engineers can repair the inverter!

Most errors and malfunctions will be displayed. The following table proposes solutions to several possible problems.

No.	Failure	solution
1	LED indicator and LCD screen do not light up	1. Disconnect AC side circuit breaker.
		2. Disconnect DC side circuit breaker.
		3. Check the input voltage of the PV arrays (whether it is lower than 180V).
		4.If the above conditions are met, check the circuit breaker.
2	"on line" indicator goes off	1. Disconnect AC side circuit breaker.
		2. Disconnect DC side circuit breaker.
		3.Check whether the parameters on the AC and DC sides meet the startup requirements. If the parameters meet the requirements, check the wiring according to 4.4 Electrical connection.
3	PV arrays voltage fault (DC voltage>1000V or <180V)	1. Disconnect AC side circuit breaker.
		2. Disconnect DC side circuit breaker.
		3. Check whether the voltage of each group of PV arrays meets the range of 180V-1000V.
		4. When the DC voltage is restored to the allowable range of the inverter, restart the inverter.
4	Unet fault (the grid voltage>265V or <170V)	1. Disconnect AC side circuit breaker.
		2. Disconnect DC side circuit breaker.
		3.Detect the voltage on the AC side.
		4.If the grid voltage is not within the allowable voltage range of the inverter, please contact the supplier to adjust the grid voltage.
5	Frequency fault (the grid frequency is neither 47.5-52.5Hz nor 57.5-62.5Hz)	1. Disconnect AC side circuit breaker.
		2. Disconnect DC side circuit breaker.
		3.Detect the frequency on the AC side.
		4.If the current grid frequency is not in the inverter's allowable frequency range, please contact the local power company to adjust the grid frequency.
6	Temperature fault 120℃ (inverter temperature is over limit)	1. Disconnect AC side circuit breaker.
		2. Disconnect DC side circuit breaker.
		3. Check whether the ambient temperature is higher than 60 ℃

		4. Please check whether the ventilation of the machine is normal, whether the hook-up installation is correct, and whether the air duct is unblocked.
		5. Whether the output power exceeds the rated value.
7	Grounding fault	1. Disconnect AC side circuit breaker.
		2. Disconnect DC side circuit breaker.
		3. Check whether the ground resistance of each group of PV arrays is greater than $2M \Omega$.

Table 8-1 troubleshooting

If the fault cannot be solved or your problem is not mentioned in the above table, please contact supplier.

9

Specification

9.1 Specification

Technical Data	AU18K3P-LV	AU20K3P-LV	AU25K3P-LV	AU30K3P-LV
DC Input Data				
Max. DC input power (KW)	27000W	30000W	37500	45000W
Max. DC input voltage(VDC)	1000			
Max. DC input current(A)	30A/30A/30A/30A		36A/36A/20A/20A	
MPPT voltage range(VDC)	180~1000			
Recommended working voltage(VDC)	360			
MPPT number	4			
Max. input strings per MPP tracker	2/2/2/2			
AC Output Data				
Rated output power (KW)	18000W	20000W	25000W	30000W
Max. AC power (KVA)	19.8kVA	22kVA	27.5kVA	33kVA
Max. output current(A)	51.9A	57.7A	72.1A	86.6A
Rated power grid voltage(Vac)	127/220V			
Power grid voltage range(Vac)	170-265			
Rated power grid frequency	50Hz/60Hz			
Grid frequency range	47.5~52.5Hz/57.5~62.5Hz			
THD	<2%(Under the rated power)			
Power factor	>0.99(Under rated power)/Adjustable range0.8(Leading)~0.8 (Lagging)			
DC component	<0.5%(Under rated power)			
System Data				
Max. Efficiency(%)	98.7%	98.7%	98.7%	98.7%
Euro. efficiency(%)	98.2%	98.1%	98.2%	98.2%
Humidity	0~100%, No condensation			
Cooling	Fan			
Allowed ambient temperature	-25°C ~ +60°C			

range	
Consumption during night	<1W
Altitude allowed	4000m
Communication interface	RS485/WIFI/GPRS((optional)
Display	LED/LCD(optional)
Mechanical Data	
Size (width x height x depth)	610mm×564mm×218mm
Weight	39kg
Protection class	IP66
Conforming standards	
Standards for grid connection	NB/T32004-2018;IEC61727
Safety standard	NB/T32004-2018; IEC62109-1/2
EMC	IEC61000-6-2/4

9.2 Quality guarantee

- ✧ The warranty period of this product shall be subject to the contract.
- ✧ condition
- AUSTA will repair or replace the faulty products free of charge during the warranty period.
- Unqualified products after replacement shall be returned to AUSTA.
- The customer shall allow AUSTA a reasonable amount of time to repair faulty equipment.
- ✧ The company reserves the right not to guarantee quality in the following cases:
 - Transport damage.
 - Incorrect installation.
 - Incorrect modification.
 - Incorrect use.
 - Operate beyond the very harsh conditions described in this manual.
 - Any installation and use outside the scope specified in relevant international standards.
 - Damage caused by abnormal natural conditions.

Feedback Form

Name of Company			
Address			
Contact person		Title	
Telephone No.		Fax No.	
Email Address			
Company's filed of business			
Comments:			

Thank you for taking time to share your feedback. Your comments and suggestions will help us to serve you better.

Please send fax or e-mail your feedback, we will respond you within 24 hours.

Contact Information

NINGBO AUSTA SOLAR TECH CO.,LTD.

Tel: +86 574 89137130

Email: marketing@osdasol.com

Web:www.austasolar.net

Add: 1-1 NO.136 Haichuan Road Jiangbei

District Ningbo Zhejiang P.R. China



NINGBO AUSTA SOLAR TECH CO.,LTD.

Tel: +86 574 89137130

Email: marketing@osdasol.com

Web: www.austasolar.net

Add: 1-1 NO.136 Haichuan Road Jiangbei

District Ningbo Zhejiang P.R. China